

Ion trap quantum processor

Laser pulses manipulate individual ions

row of qubits in a linear Paul trap forms a quantum register

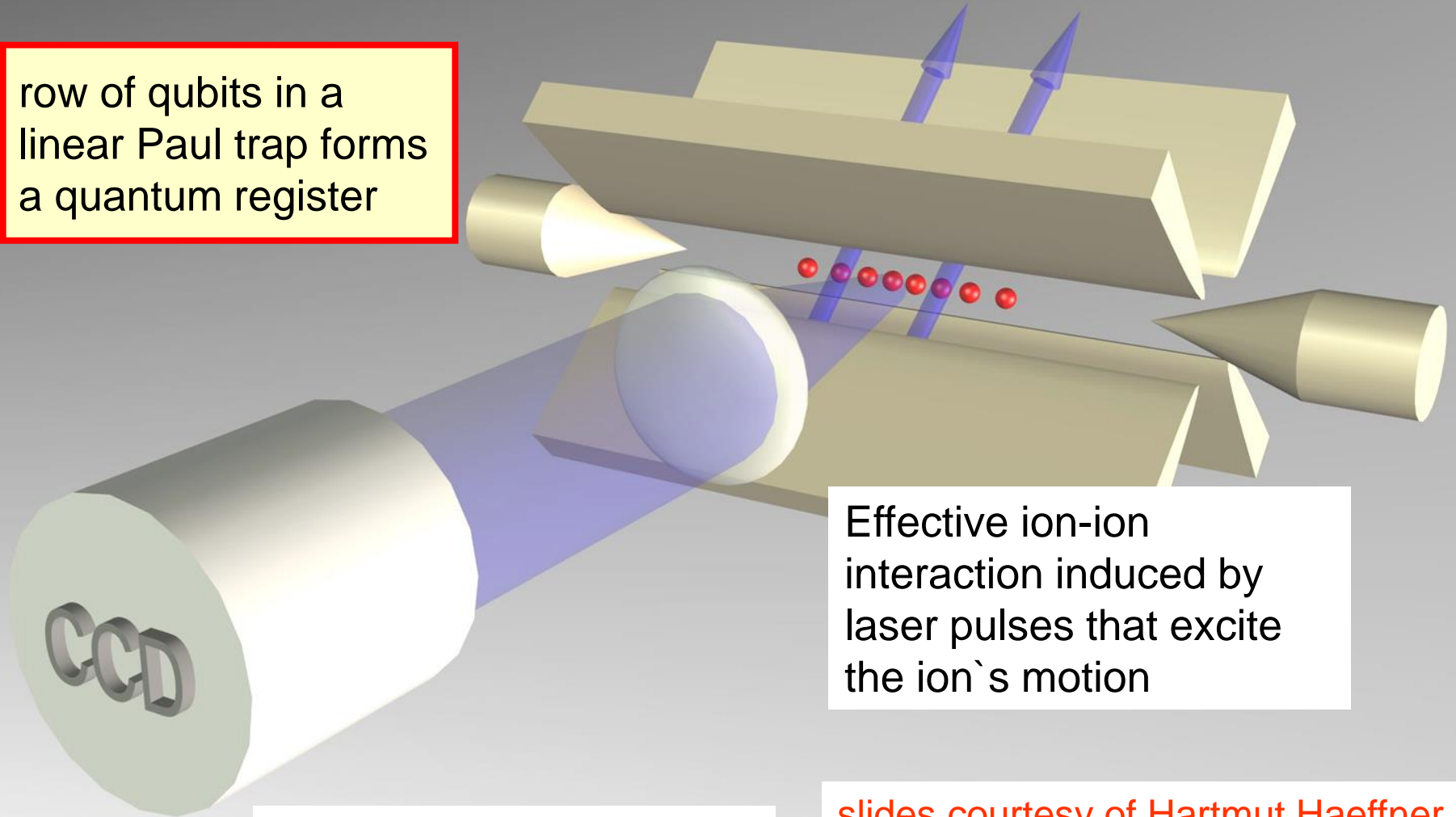

Effective ion-ion interaction induced by laser pulses that excite the ion`s motion

A CCD camera reads out the ion`s quantum state

slides courtesy of Hartmut Haeffner, Innsbruck Group with some notes by Andreas Wallraff, ETH Zurich

Meeting the DiVincenzo criteria with trapped ions

criterion	physical implementation	
scalable qubits	internal atomic transitions (2-level-systems)	linear traps (trap arrays)
initialization	laser cooling, state preparation	optical pumping, laser pulses
long coherence times	narrow transitions (optical, microwave)	coherence time ~ ms - min
universal quantum gates	single qubit operations, two-qubit operations	Rabi oscillations Cirac-Zoller CNOT
qubit measurement	quantum jump detection	individual ion fluorescence
convert qubits to flying qubits	coupling of ions with high finesse cavity	CQED, bad cavity limit
faithfully transmit flying qubits	coupling of cavities via fiber (photonic channel)	coupling pulse sequences (CZKM)

Trapping Individual Ions

Linear Paul trap

2D rf-trap + static potential

I. Waki et al., Phys. Rev. Lett. 68, 2007 (1992)
M.G. Raizen et al., Phys. Rev. A 45, 6493 (1992)

plug the ends of a mass filter by positive electrodes:

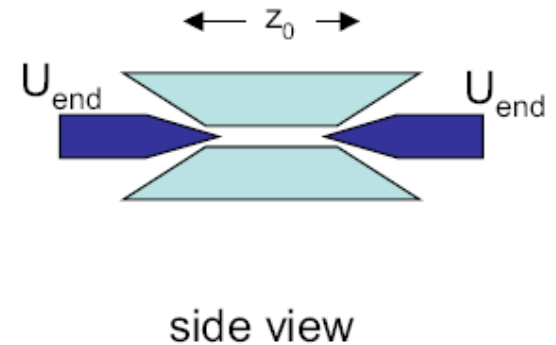
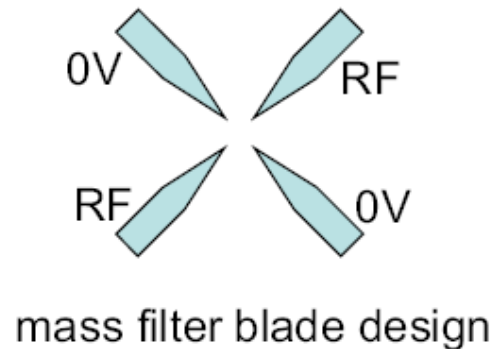
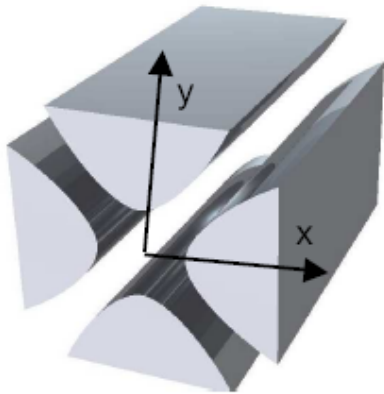

numerically calculate the axial electric potential,
fit **parabola** into the potential
and get the axial trap frequency

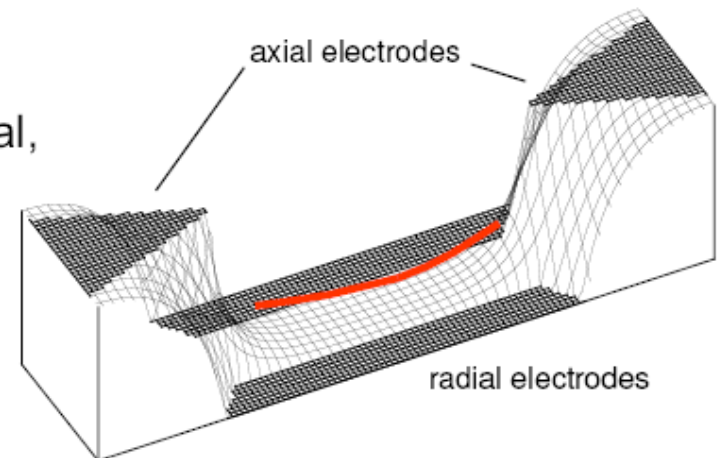

Innsbruck: Linear ion trap (2000)

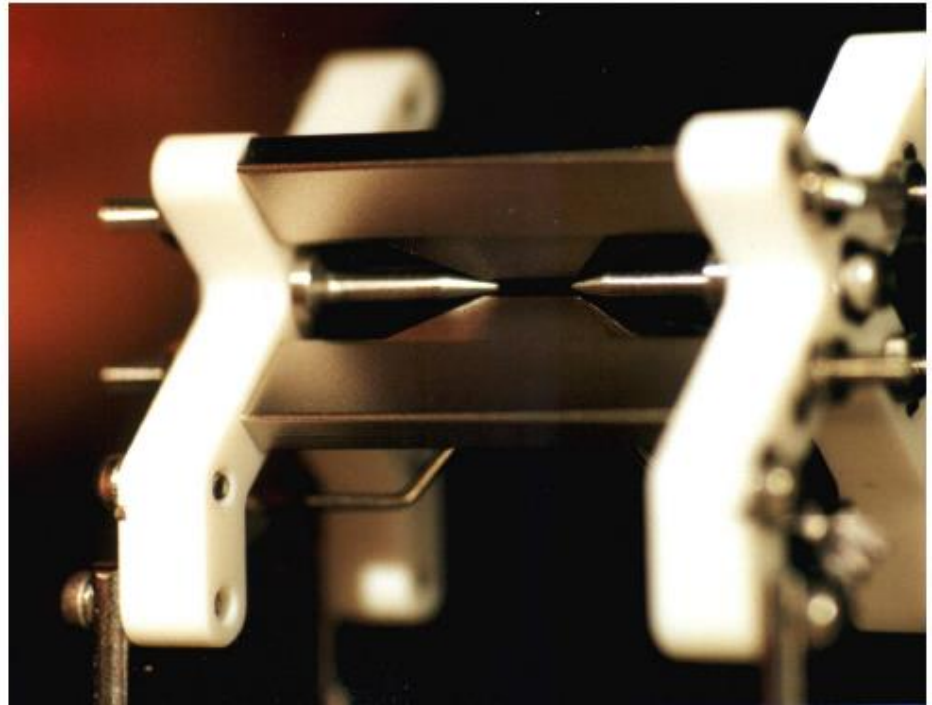
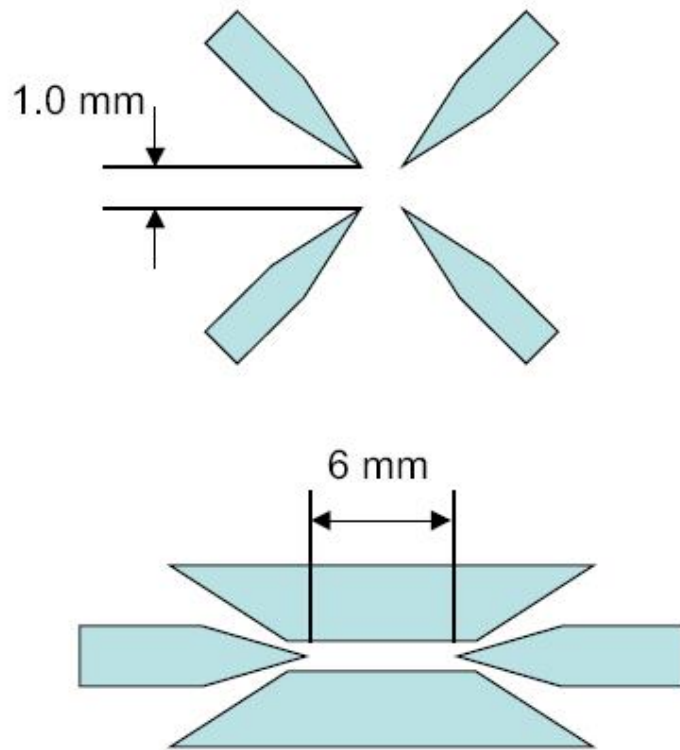

$$\omega_z \approx 0.7 - 2 \text{ MHz} \quad \omega_{x,y} \approx 1.5 - 4 \text{ MHz}$$

Experimental setup

Fluorescence
detection by

CCD camera
photomultiplier

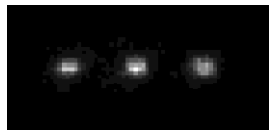

CCD
camera

Photo-
multiplier

Laser beams for:

photoionization
cooling
quantum state manipulation
fluorescence excitation

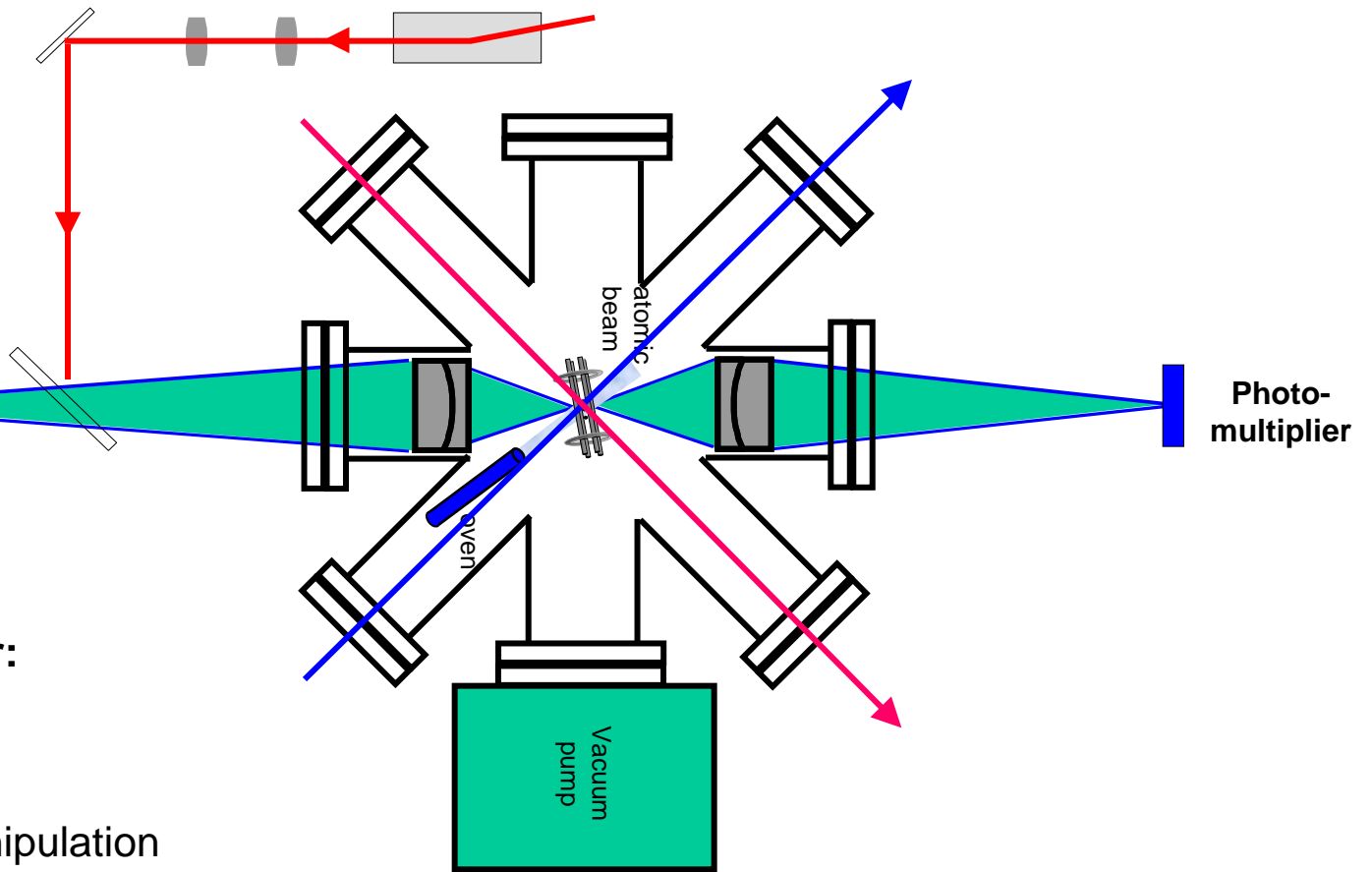

Experimental setup

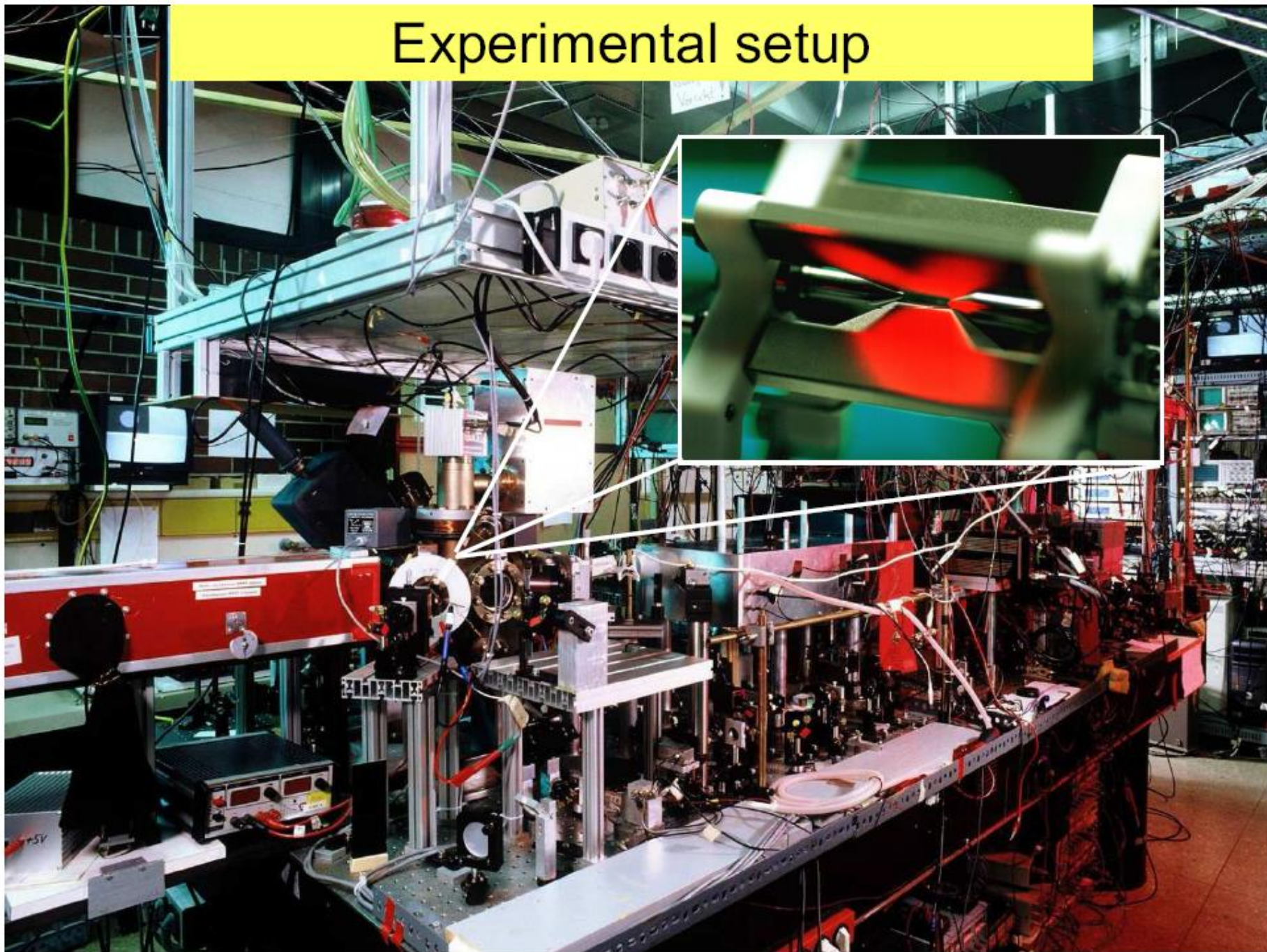

Ion strings

In strongly anisotropic traps: Formation of linear strings of ions

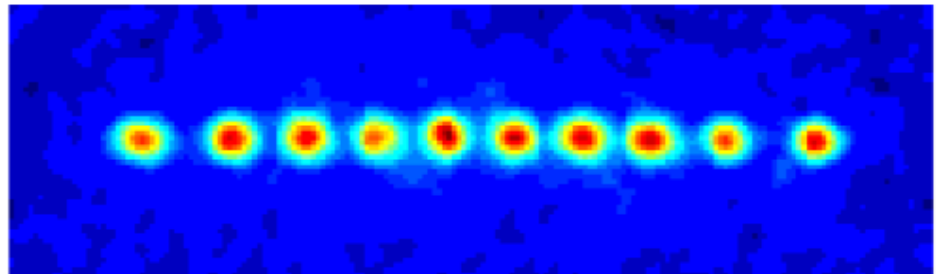
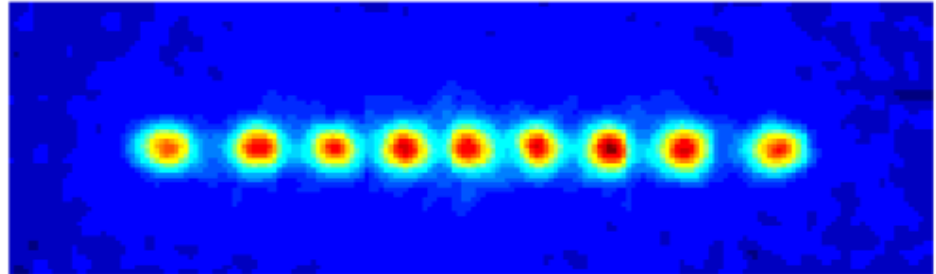
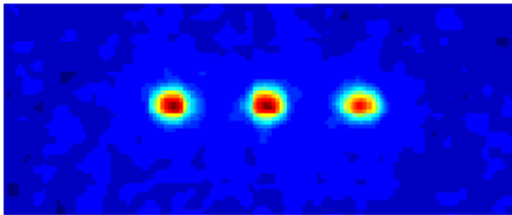
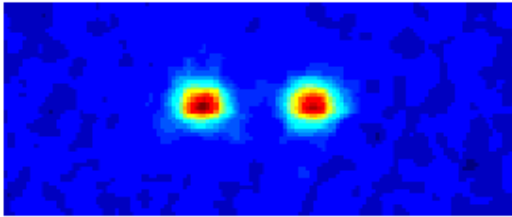
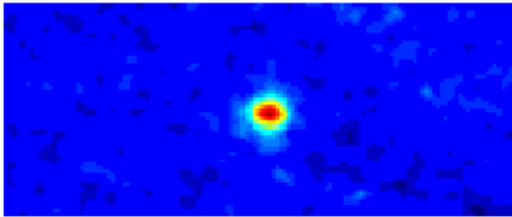

Ions as Quantum Bits

Ions with optical transition to metastable level: $^{40}\text{Ca}^+$, $^{88}\text{Sr}^+$, $^{172}\text{Yb}^+$

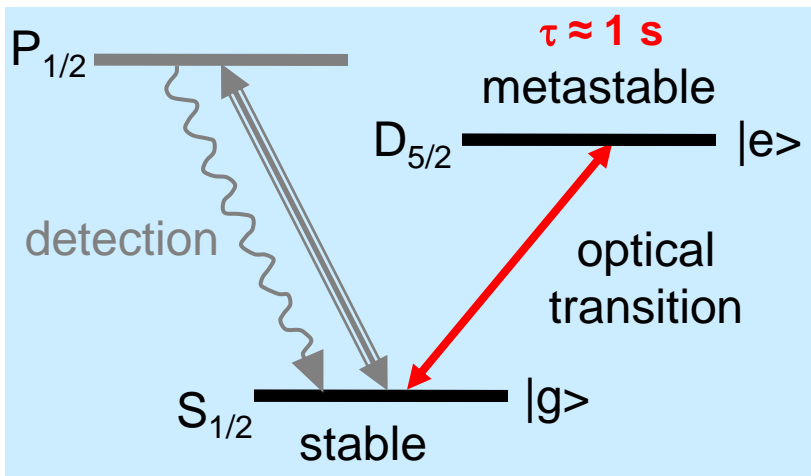

Qubit levels: $S_{1/2}$, $D_{5/2}$

Qubit transition: Quadrupole transition
 $S_{1/2} - D_{5/2}$

Detection of Ion Quantum State

Quantum jumps: spectroscopy with quantized fluorescence

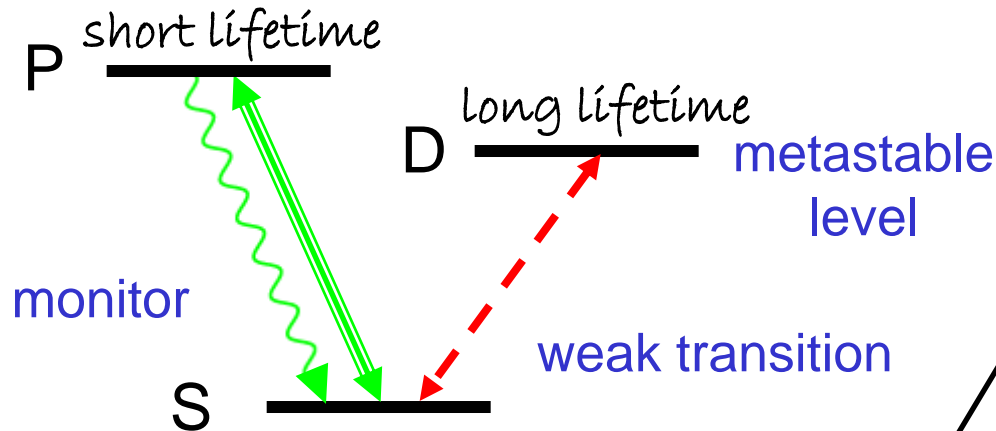

absorption and emission cause fluorescence steps (digital quantum jump signal)

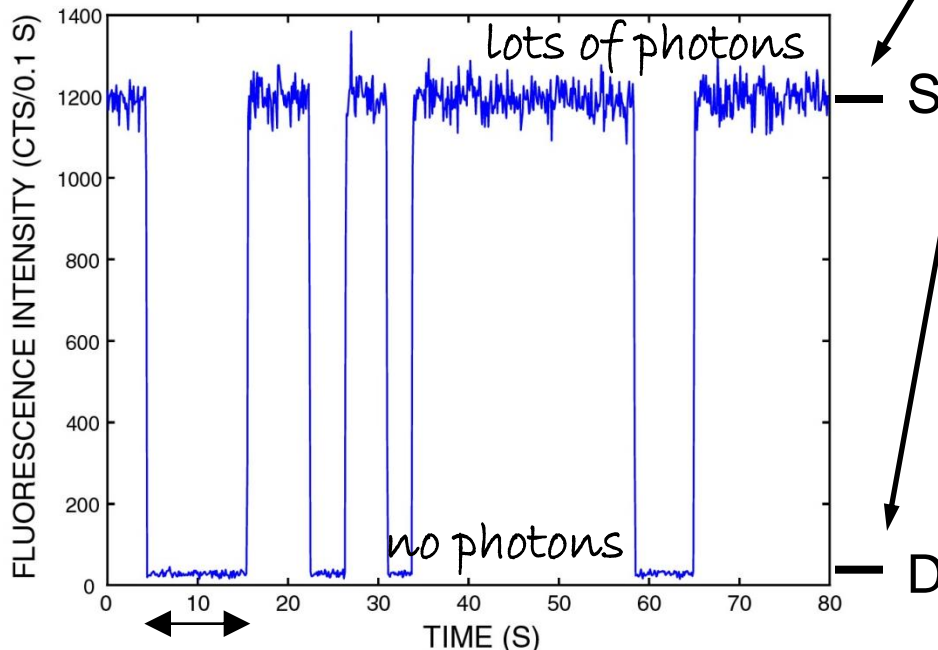

time in excited state (average is lifetime)

„ Quantum jump technique“
„ Electron shelving technique“

Observation of quantum jumps:

Nagourney et al., PRL **56**,2797 (1986),
Sauter et al., PRL **57**,1696 (1986),
Bergquist et al., PRL **57**,1699 (1986)

Electron shelving for quantum state detection

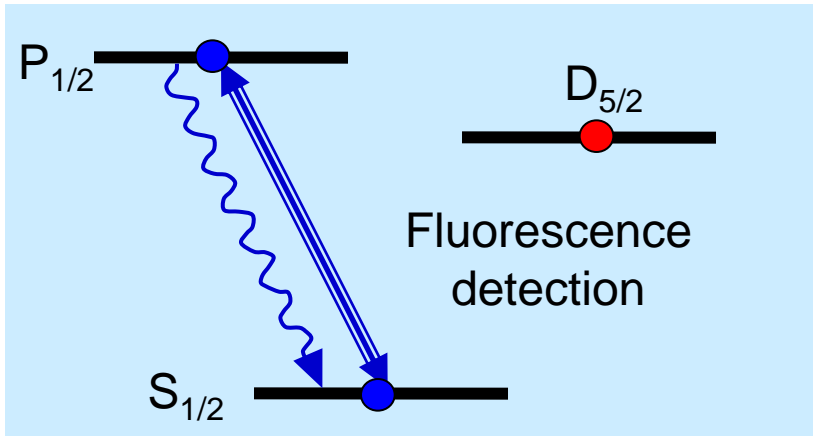

1. Initialization in a pure quantum state

2. Quantum state manipulation on $S_{1/2} - D_{5/2}$ transition

3. Quantum state measurement by fluorescence detection

One ion : Fluorescence histogram

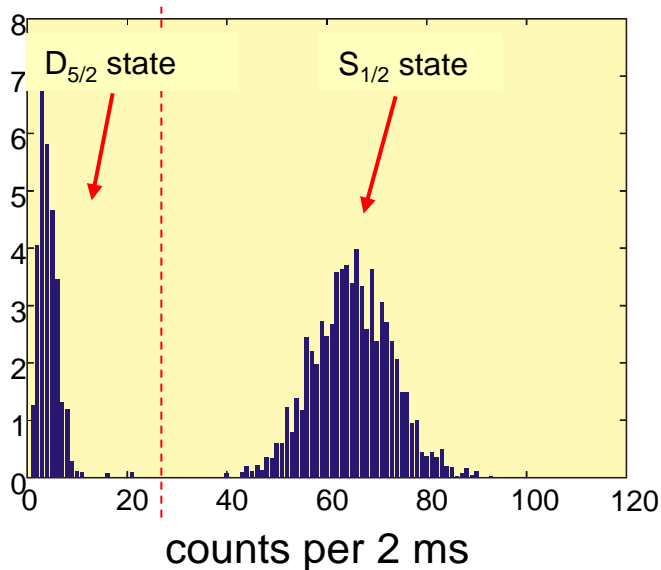

50 experiments / s

Repeat experiments
100-200 times

Electron shelving for quantum state detection

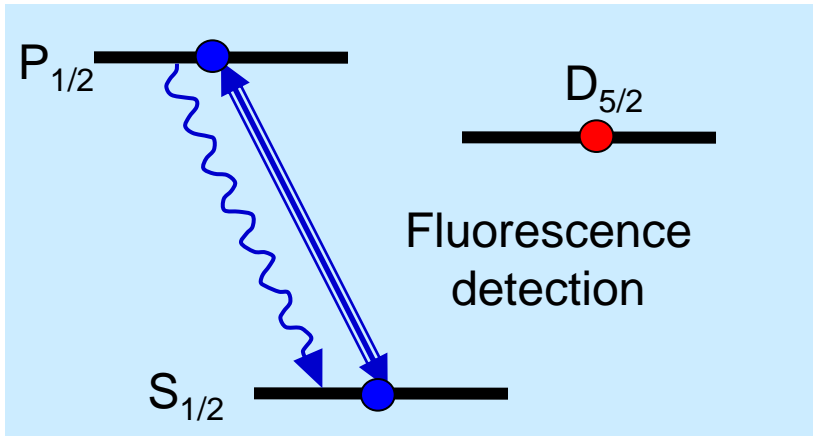

1. Initialization in a pure quantum state

2. Quantum state manipulation on $S_{1/2} - D_{5/2}$ transition

3. Quantum state measurement by fluorescence detection

Two ions:

Spatially resolved detection with CCD camera:

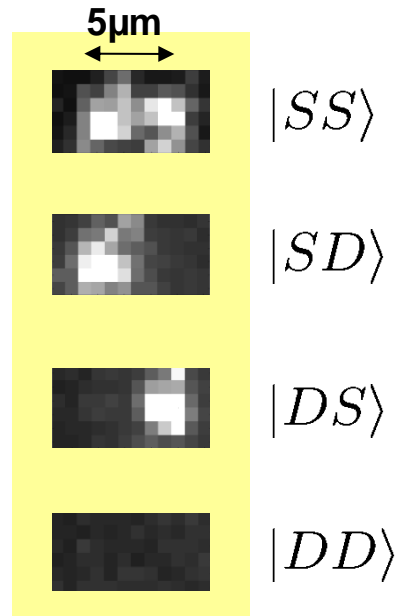

50 experiments / s

Repeat experiments
100-200 times

Mechanical Motion of Ions in their Trapping Potential:

Mechanical **Quantum** harmonical oscillator

Extension of the ground state:

$$x = \sqrt{\frac{\hbar}{2m\nu}}(a + a^\dagger)$$

$$\langle 0|x^2|0\rangle = \frac{\hbar}{2m\nu}\langle 0|(a + a^\dagger)^2|0\rangle = \frac{\hbar}{2m\nu}$$

$$\left. \begin{array}{l} \nu = (2\pi)1 \text{ MHz} \\ m=40 \text{ u} \end{array} \right\} \langle x^2 \rangle^{1/2} = \sqrt{\frac{\hbar}{2m\nu}} \approx 11 \text{ nm}$$

harmonic trap

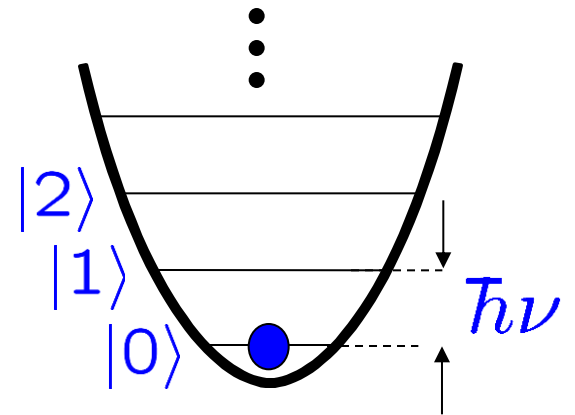

Size of the wave packet \ll wavelength of visible light

Energy scale of interest:

$$\hbar\nu = k_B T \quad \longrightarrow \quad T = \frac{\hbar\nu}{k_B} \approx 50 \mu\text{K}$$

ions need to be very cold to be in their vibrational ground state

An Ion Coupled to a Harmonic Oscillator

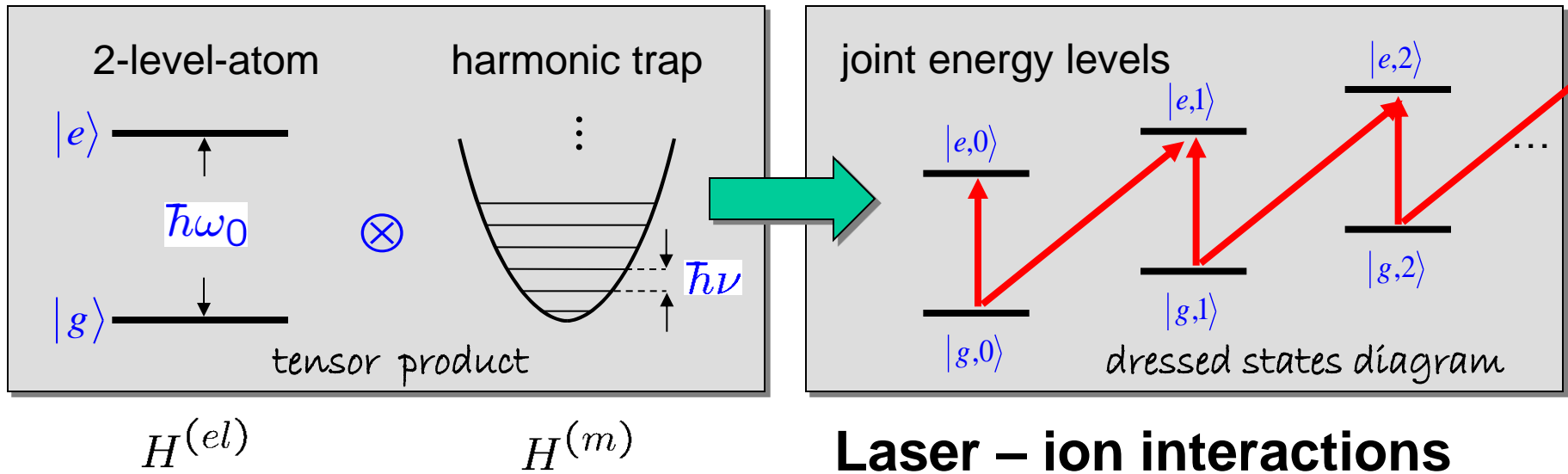

Approximations:

Ion: Electronic structure of the ion approximated by two-level system
 (laser is (near-) resonant and couples only two levels)

$$H^{(el)} = \hbar \frac{\omega_0}{2} (|e\rangle\langle e| - |g\rangle\langle g|)$$

Trap: Only a single harmonic oscillator taken into account

$$H^{(m)} = \hbar\nu a^\dagger a$$

External degree of freedom: ion motion

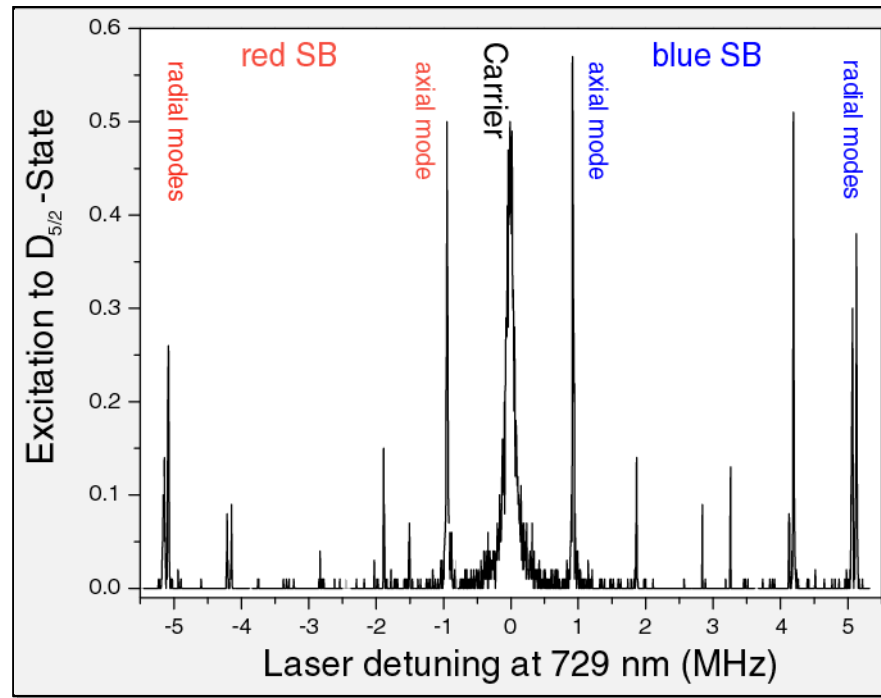
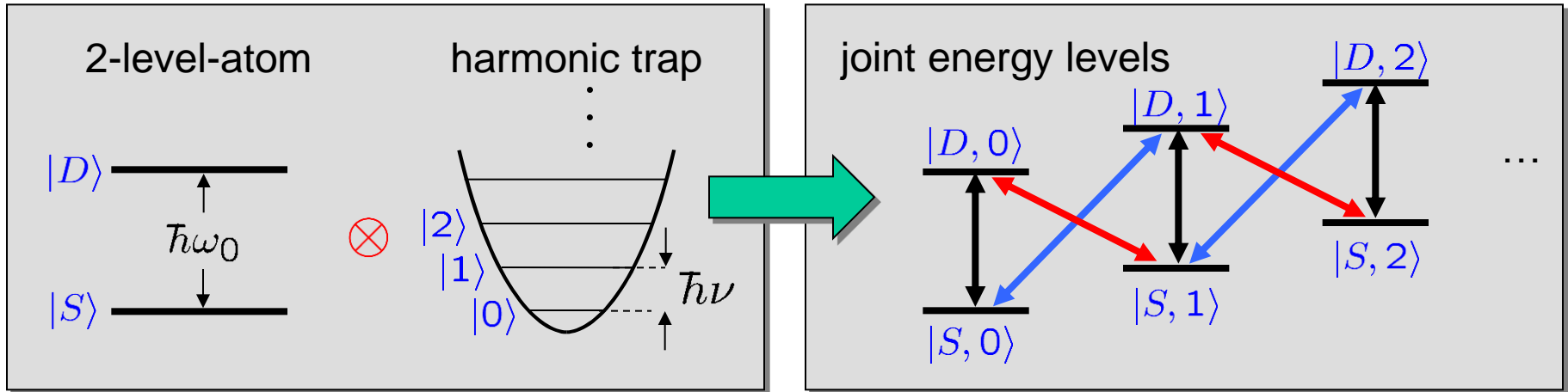

ion transition
frequency 400 THz

trap frequency 1 MHz

A closer look at the excitation spectrum (3 ions)

$$S_{1/2, m = -1/2} \longleftrightarrow D_{5/2, m = -1/2}$$

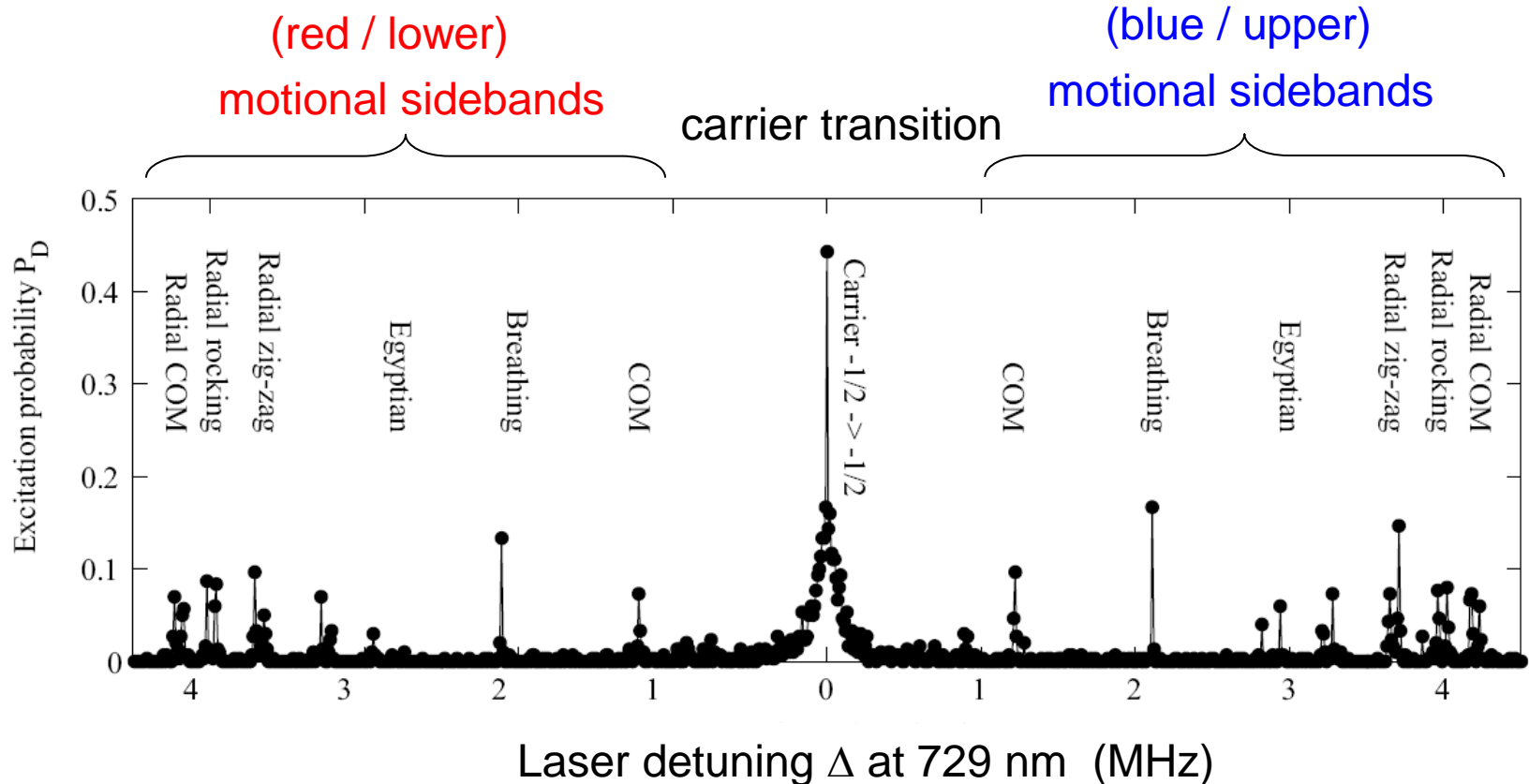

many different vibrational modes of ions in the trap

red and blue side bands can be observed because
vibrational motion of ions is not cooled (in this example)

Stretch mode excitation

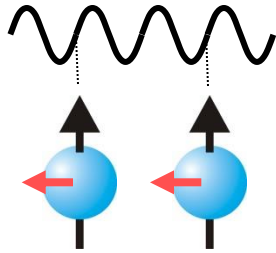

no differential force

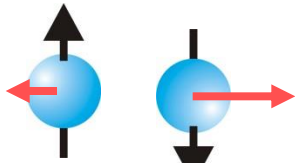
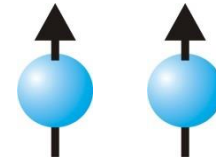

differential force

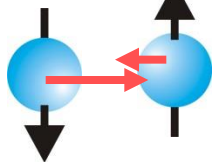
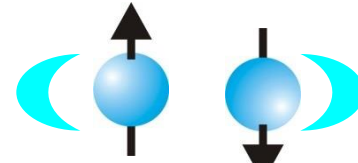

differential force

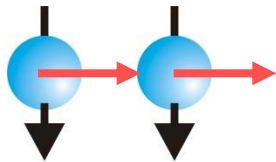
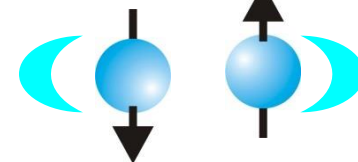

no differential force

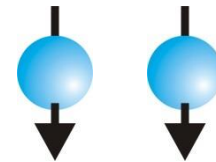

Cooling of the vibrational modes

Sideband absorption spectra

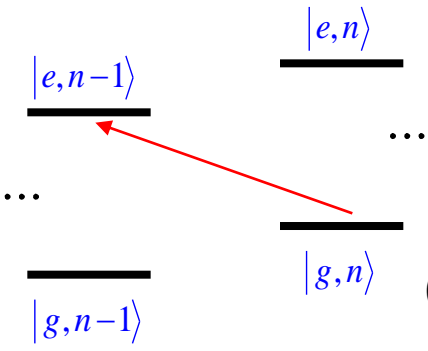

99.9 % ground state population

red side band transition

after sideband cooling

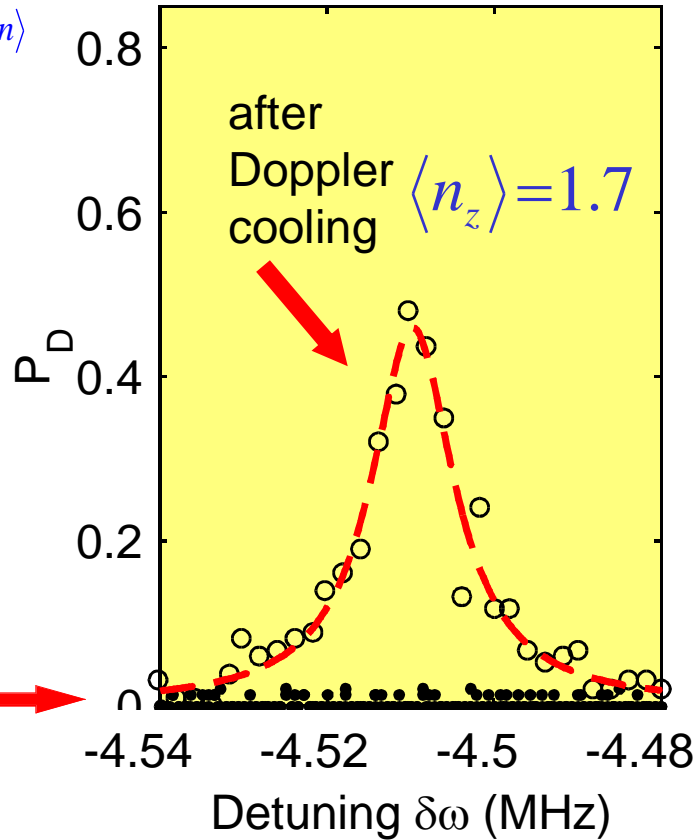

red sideband

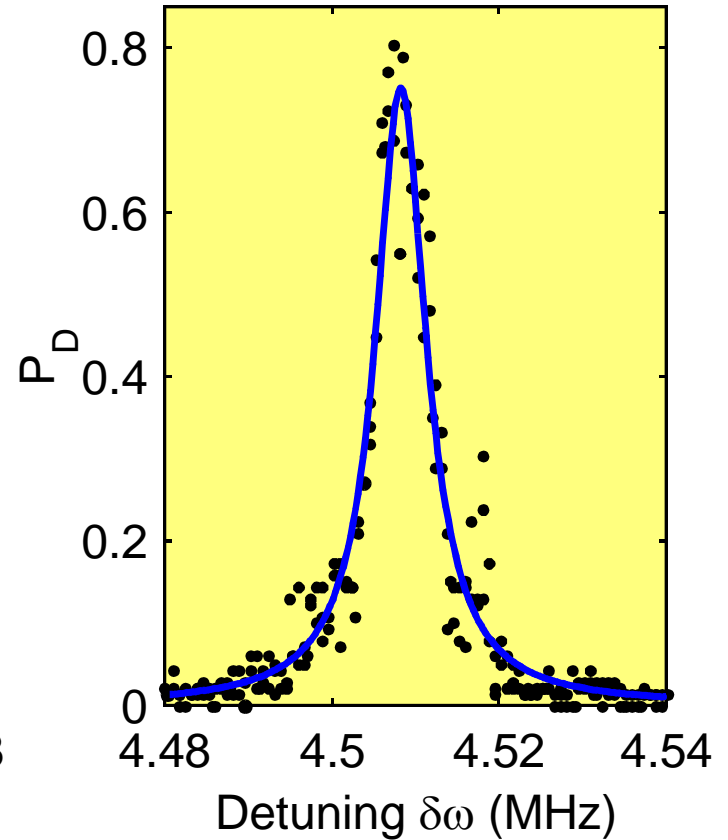

blue sideband

But also controlled excitation of the vibrational modes

Coherent excitation on the sideband

„Blue sideband“ pulses:

$$|S\rangle|n\rangle \longleftrightarrow |D\rangle|n+1\rangle$$

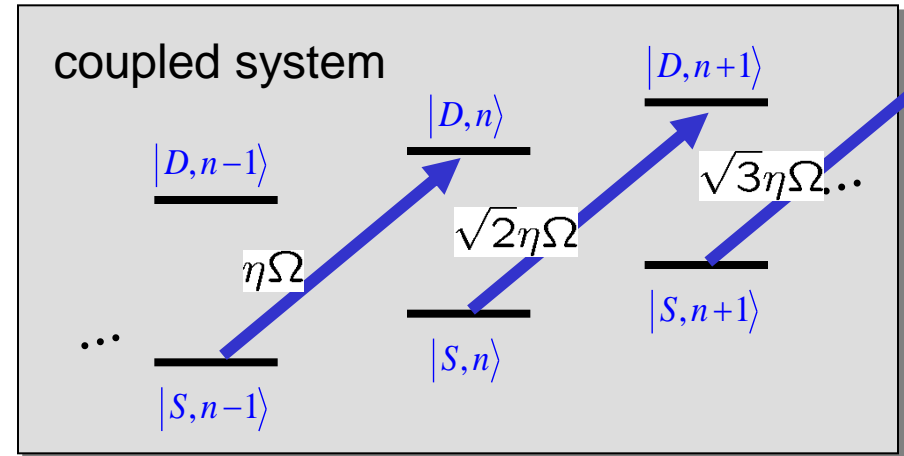

$\theta = \pi/2$: Entanglement between internal and motional state !

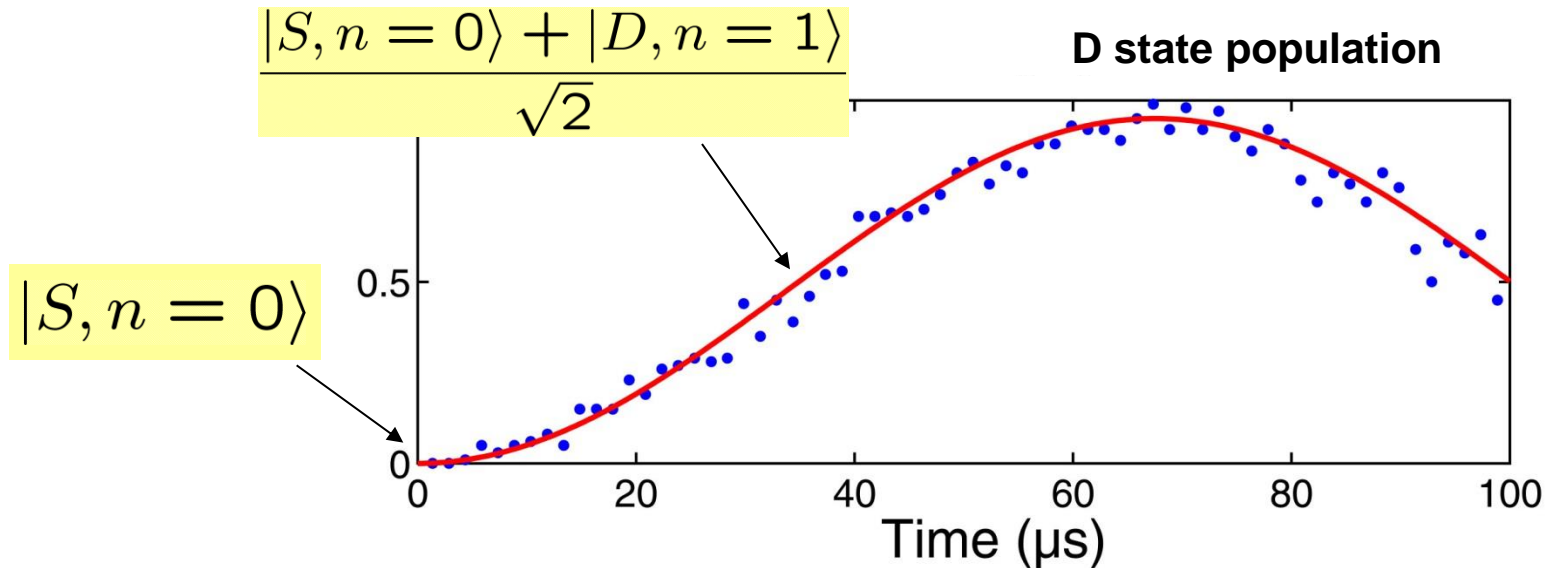

Single qubit operations

Arbitrary qubit rotations:

- Laser slightly detuned from carrier resonance

or:

- Concatenation of two pulses with rotation axis in equatorial plane

z-rotations

(z-rotations by off-resonant laser beam creating ac-Stark shifts)

x,y-rotations

Gate time : 1-10 μs

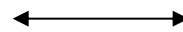

Coherence time : 2-3 ms

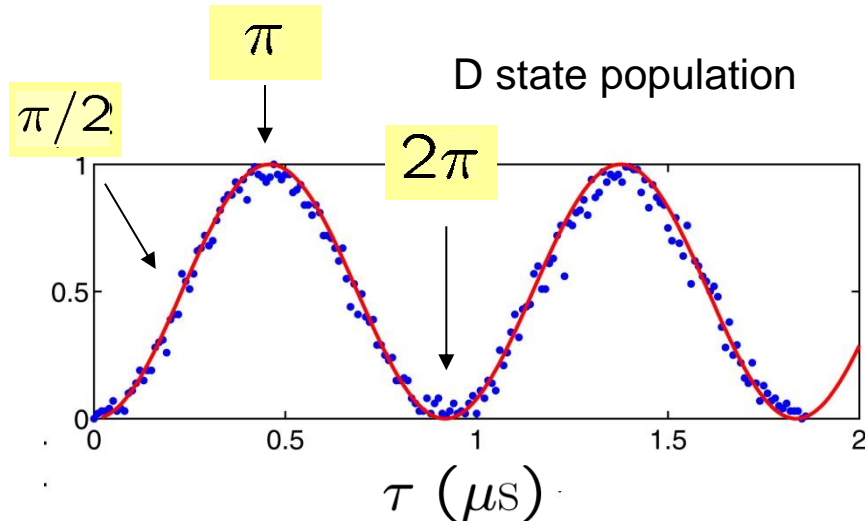

limited by

- magnetic field fluctuations
- laser frequency fluctuations
(laser linewidth $\delta\nu < 100$ Hz)

Addressing the qubits

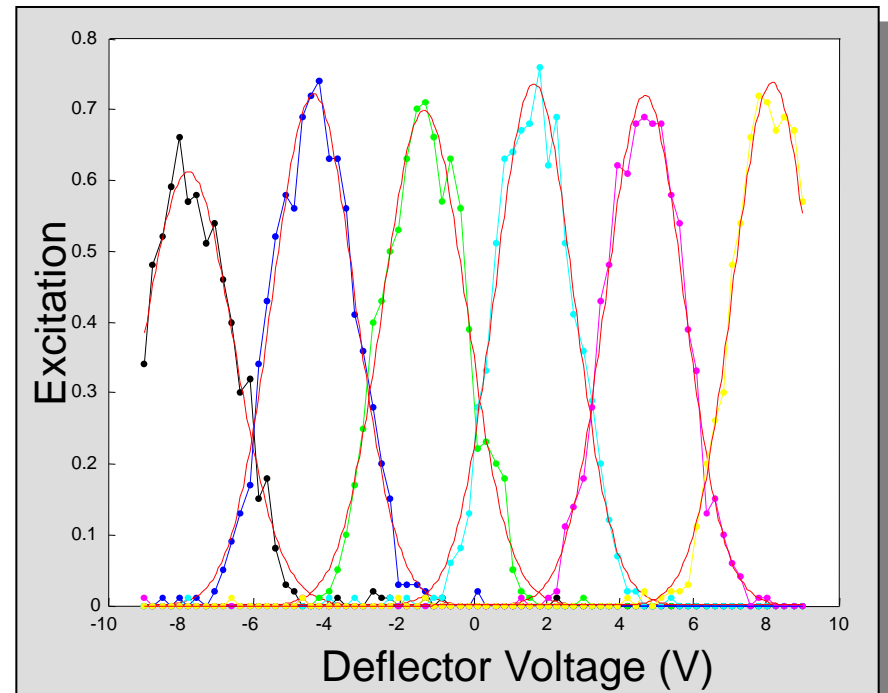
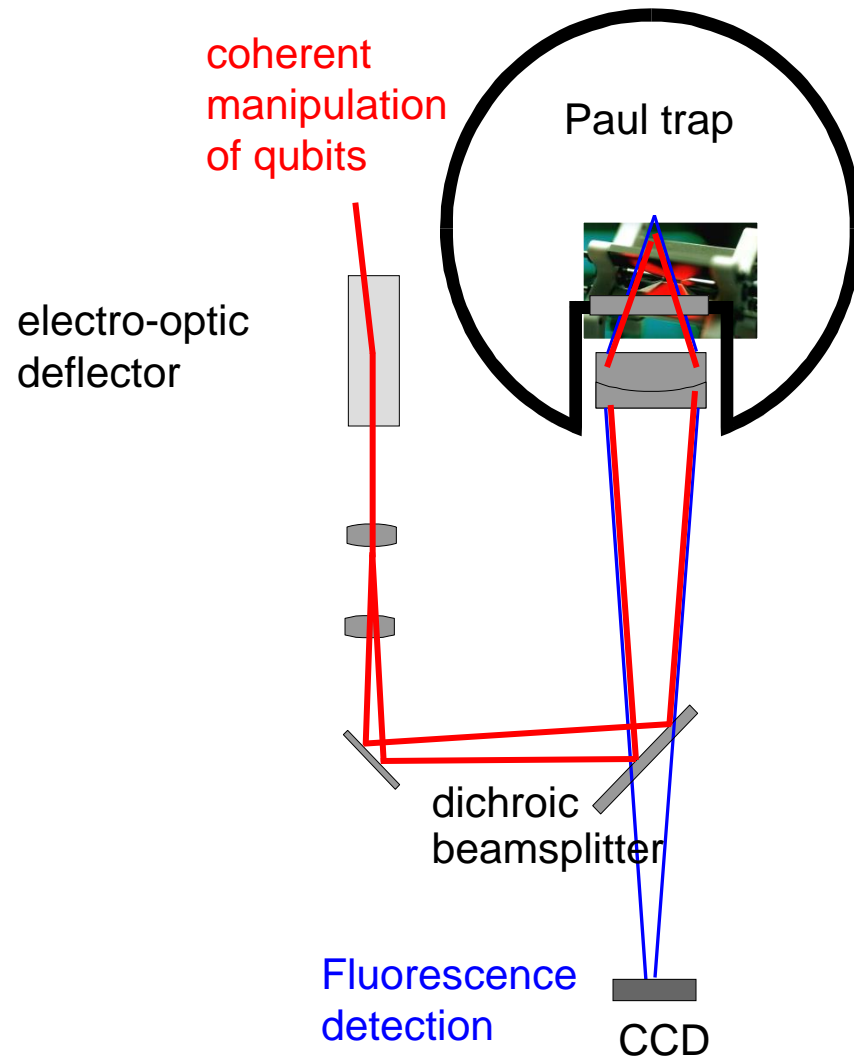
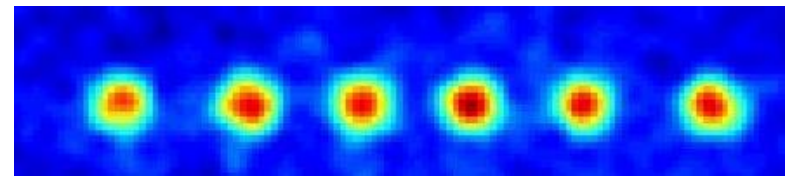

- inter ion distance: $\sim 4 \mu\text{m}$
- addressing waist: $\sim 2 \mu\text{m}$
- $< 0.1\%$ intensity on neighbouring ions

Generation of Bell states

generation of entanglement between two ions

\vdots
 $|DD1\rangle$ —
 $|DD0\rangle$ —

Pulse sequence:

\vdots \vdots
 $|DS1\rangle$ — $|SD1\rangle$
 $|DS0\rangle$ — $|SD0\rangle$

\vdots
 $|SS1\rangle$ —
 $|SS0\rangle$ — ●

$|SS0\rangle$

Generation of Bell states

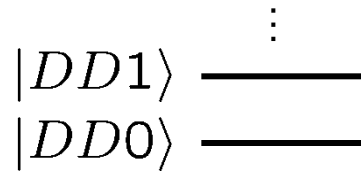

Pulse sequence:

Ion 1: $\pi/2$, blue sideband

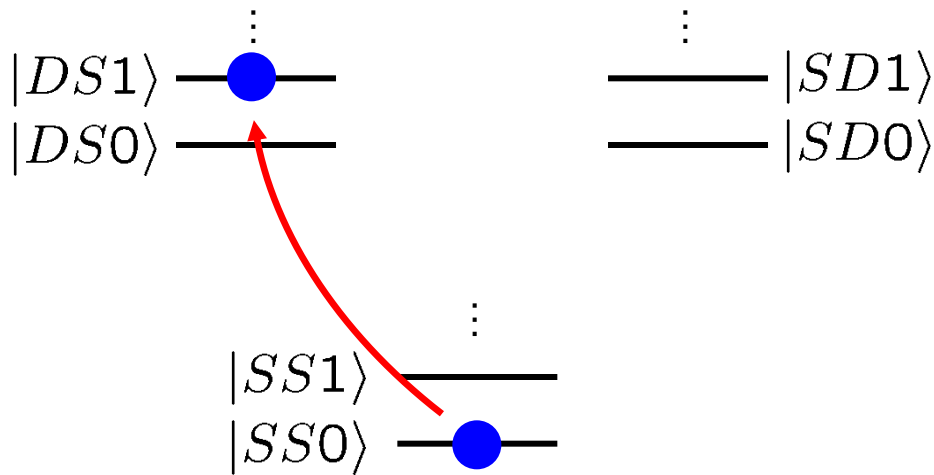

creates entangled state
between qubit 1 and oscillator

$$|SS0\rangle + |DS1\rangle$$

Generation of Bell states

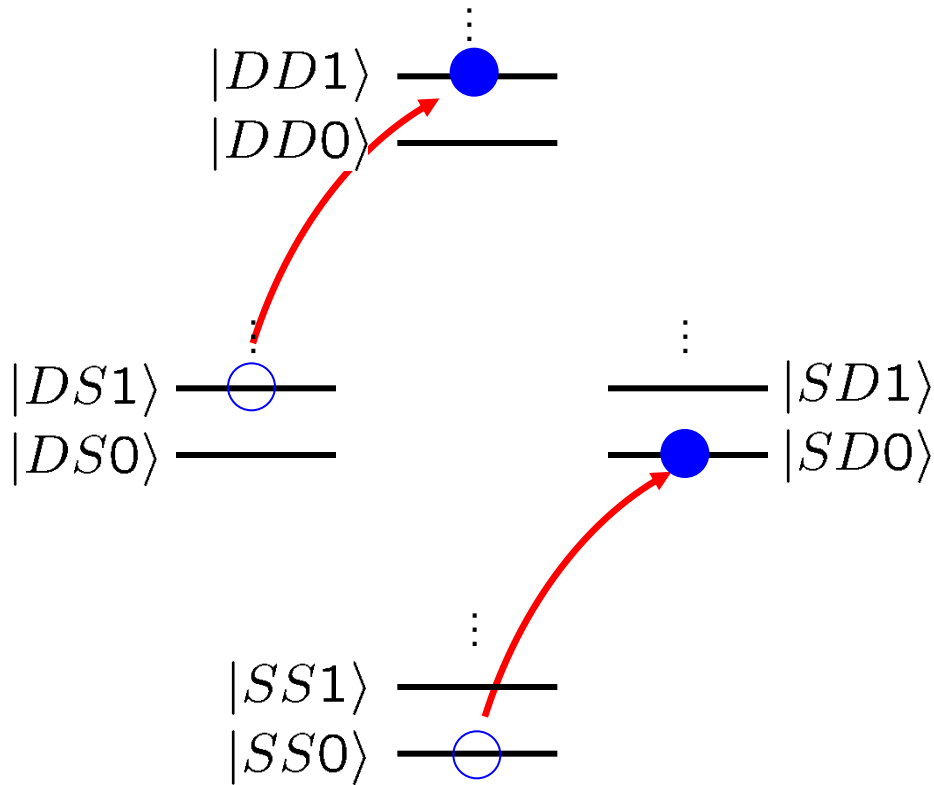

Pulse sequence:

Ion 1: $\pi/2$, blue sideband

Ion 2: π , carrier

excites qubit 2

$$|SD0\rangle + |DD1\rangle$$

Generation of Bell states

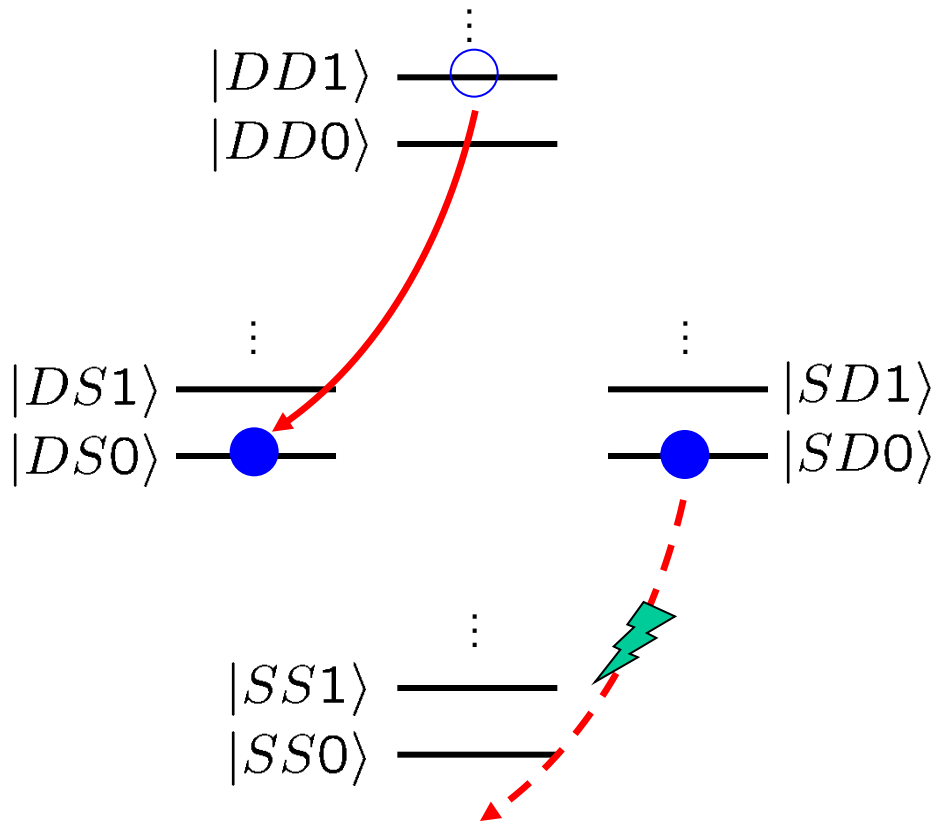

$|SD0\rangle$ is non-resonant and remains unaffected

Pulse sequence:

Ion 1: $\pi/2$, blue sideband

Ion 2: π , carrier

Ion 2: π , blue sideband

takes qubit 2 (with one oscillator excitation) back to ground state and removes excitation from oscillator

$$(|SD\rangle + |DS\rangle)|0\rangle$$

Bell state analysis

$$|SD\rangle + |DS\rangle$$

Fluorescence
detection with
CCD camera:

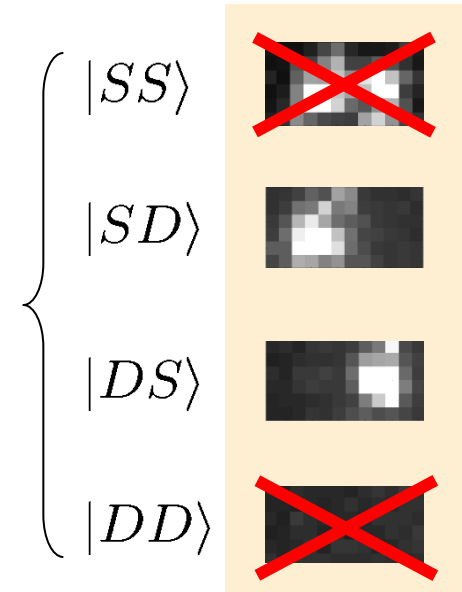

Coherent superposition or incoherent mixture ?

What is the relative phase of the superposition ?

tomography of qubit states (= full measurement of x,y,z components of both qubits and its correlations)

→ Measurement of the density matrix:

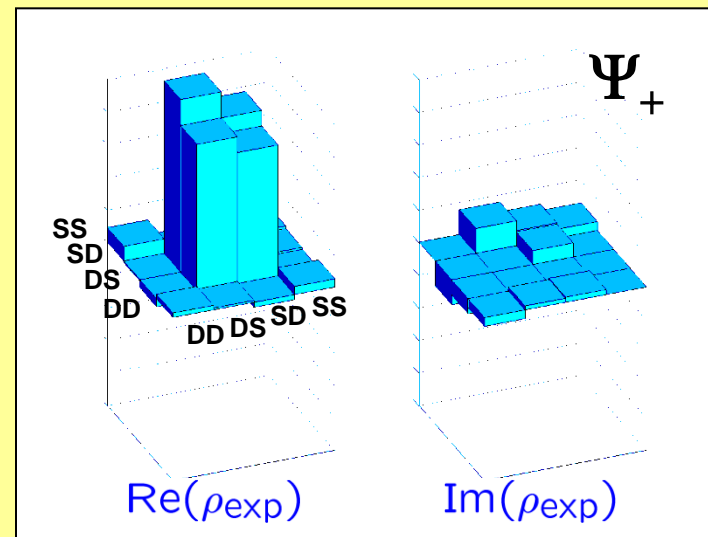

Bell state reconstruction

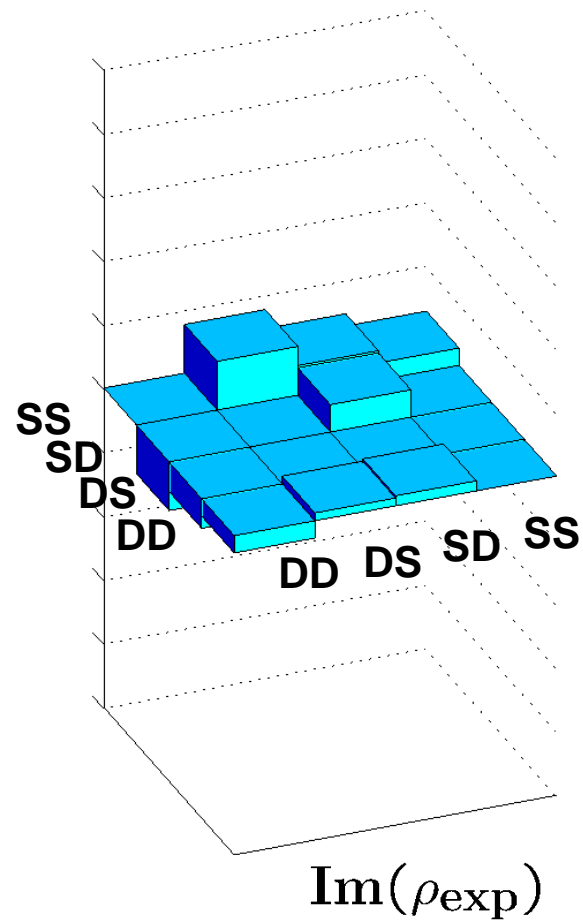
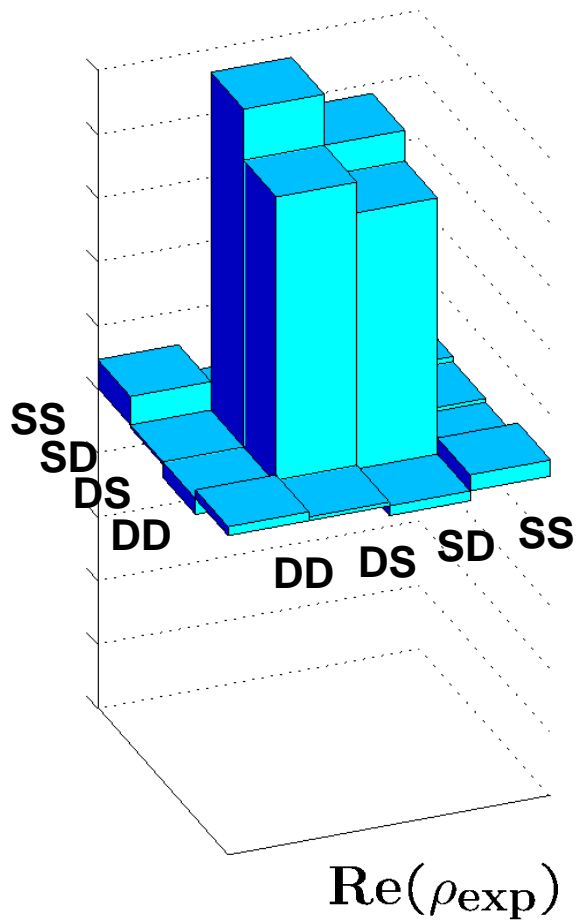

$|SD\rangle + |DS\rangle$

$F=0.91$

Controlled Phase Gate \Leftrightarrow CNOT

implementation of a CNOT for universal ion trap quantum computing

$$\xrightarrow{R_1^C(\frac{\pi}{2}, \frac{\pi}{2})}$$

Phasegate \rightarrow

$$\xrightarrow{R_1^C(\frac{\pi}{2}, -\frac{\pi}{2})}$$

$ 0\rangle \otimes 0\rangle$	$ 0\rangle \otimes (0\rangle + 1\rangle)$	$ 0\rangle \otimes (0\rangle + 1\rangle)$	$ 0\rangle \otimes 0\rangle$
$ 0\rangle \otimes 1\rangle$	$ 0\rangle \otimes (0\rangle - 1\rangle)$	$ 0\rangle \otimes (0\rangle - 1\rangle)$	$ 0\rangle \otimes 1\rangle$
$ 1\rangle \otimes 0\rangle$	$ 1\rangle \otimes (0\rangle + 1\rangle)$	$ 1\rangle \otimes (0\rangle - 1\rangle)$	$ 1\rangle \otimes 1\rangle$
$ 1\rangle \otimes 1\rangle$	$ 1\rangle \otimes (0\rangle - 1\rangle)$	$ 1\rangle \otimes (0\rangle + 1\rangle)$	$ 1\rangle \otimes 0\rangle$

Both, the phase gate as well the CNOT gate can be converted into each other with single qubit operations.

$$R^C(\pi/2, \pi/2) = \frac{1}{\sqrt{2}} \begin{pmatrix} 1 & -1 \\ 1 & 1 \end{pmatrix}$$

Together with the three single qubit gates, we can implement any unitary operation!

$$R^C(\pi/2, -\pi/2) = \frac{1}{\sqrt{2}} \begin{pmatrix} 1 & 1 \\ -1 & 1 \end{pmatrix}$$

$$\begin{array}{ccc} 00 & \rightarrow & 00 \\ 01 & \rightarrow & 01 \\ 10 & \rightarrow & 10 \\ 11 & \rightarrow & -11 \end{array}$$

controlled phase gate

$$R^C(\theta, \varphi)$$



Quantum gate proposals with trapped ions

VOLUME 74, NUMBER 20

PHYSICAL REVIEW LETTERS

15 MAY 1995

Quantum Computations with Cold Trapped Ions

J. I. Cirac and P. Zoller*

Institut für Theoretische Physik, Universität Innsbruck, Technikerstrasse 25, A-6020 Innsbruck, Austria
(Received 30 November 1994)

A quantum computer can be implemented with cold ions confined in a linear trap and interacting with laser beams. Quantum gates involving any pair, triplet, or subset of ions can be realized by coupling the ions through the collective quantized motion. In this system decoherence is negligible, and the measurement (readout of the quantum register) can be carried out with a high efficiency.

PACS numbers: 89.80.+h, 03.65.Bz, 12.20.Fv, 32.80.Pj

...allows the realization of a
universal quantum computer !

Some other gate proposals by:

- Cirac & Zoller
- Mølmer & Sørensen, Milburn
- Jonathan, Plenio & Knight
- Geometric phases
- Leibfried & Wineland

Cirac - Zoller two-ion phase gate

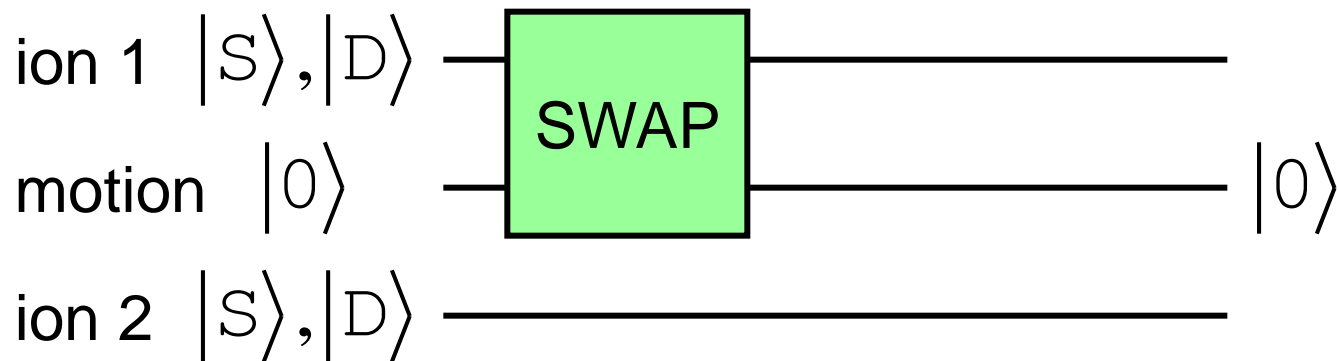
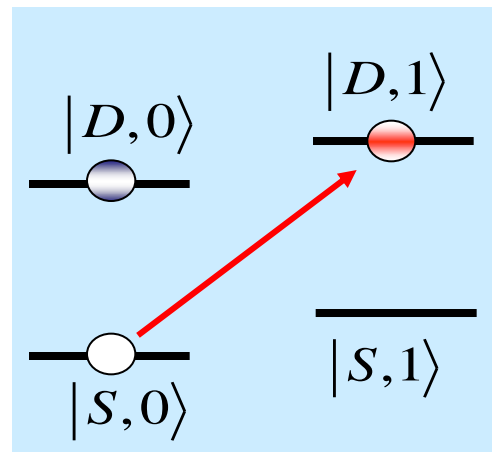
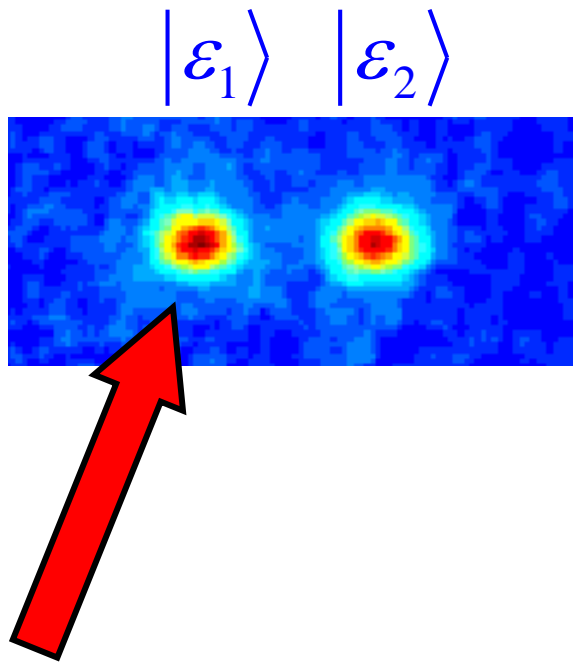

Cirac - Zoller two-ion phase gate

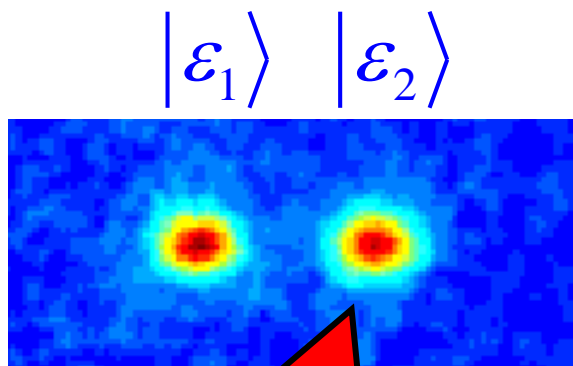

Phase gate using
the motion and
the target bit.

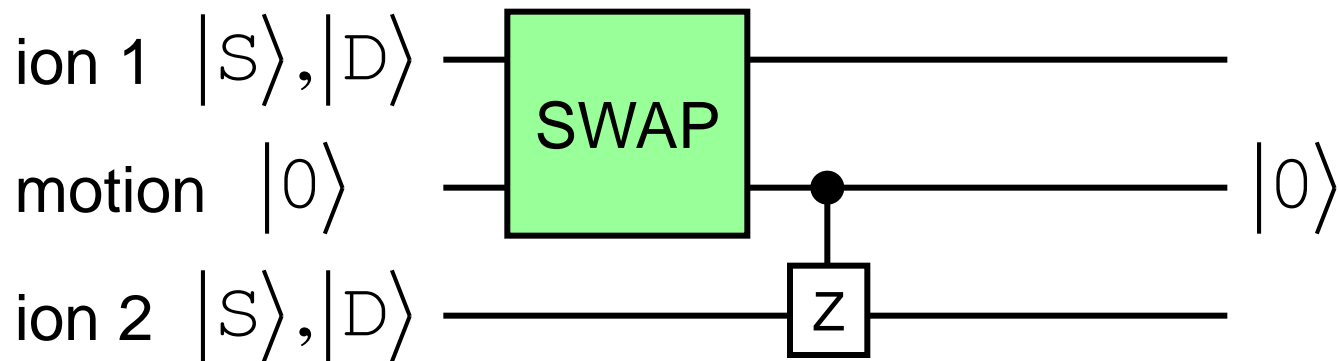

Cirac - Zoller two-ion phase gate

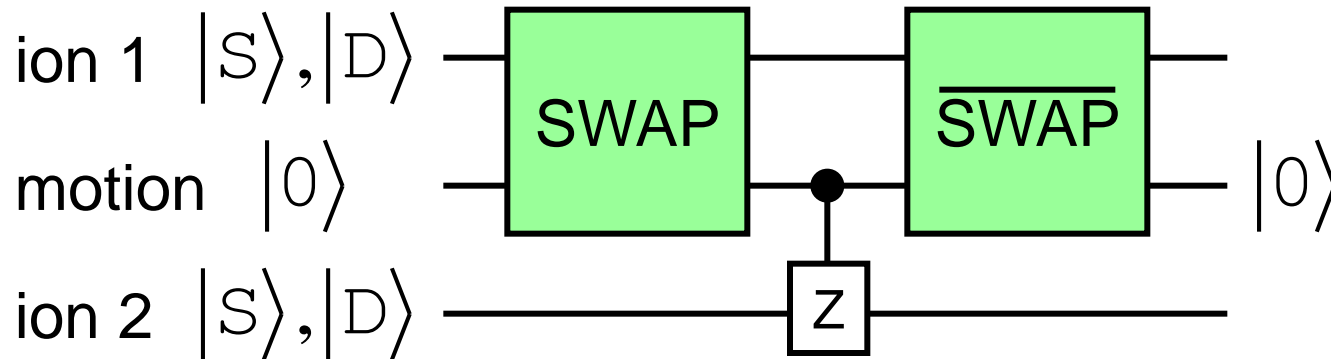
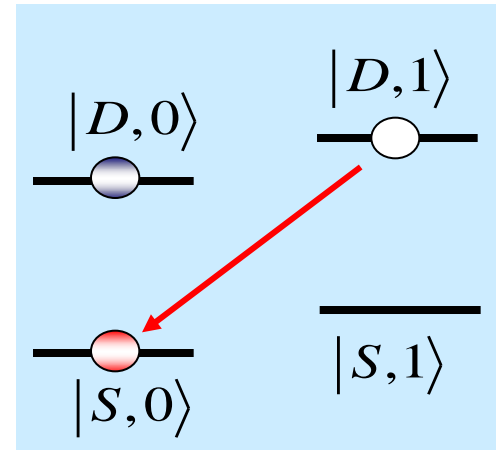
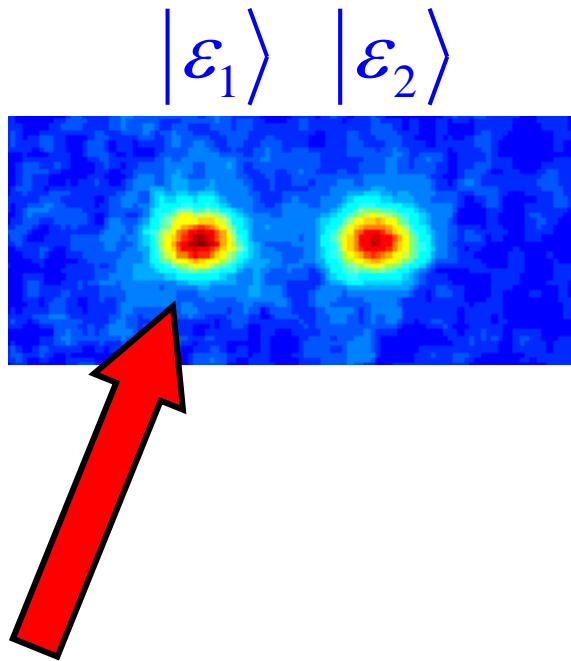

Cirac - Zoller two-ion phase gate

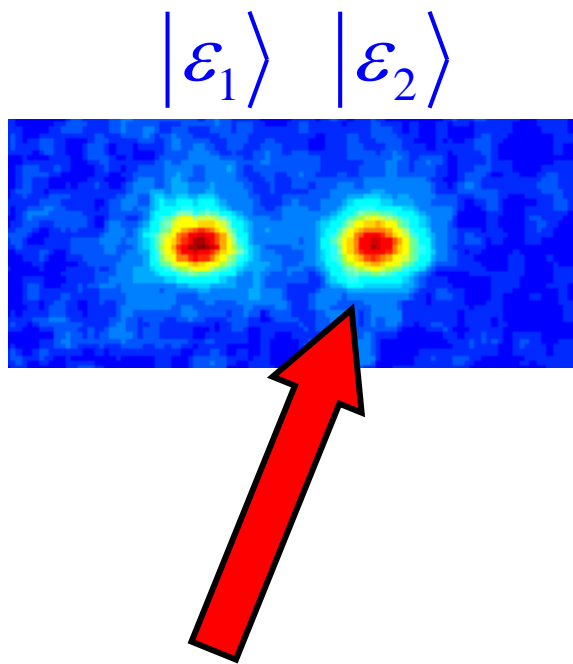

Phase gate using
the motion and
the target bit.

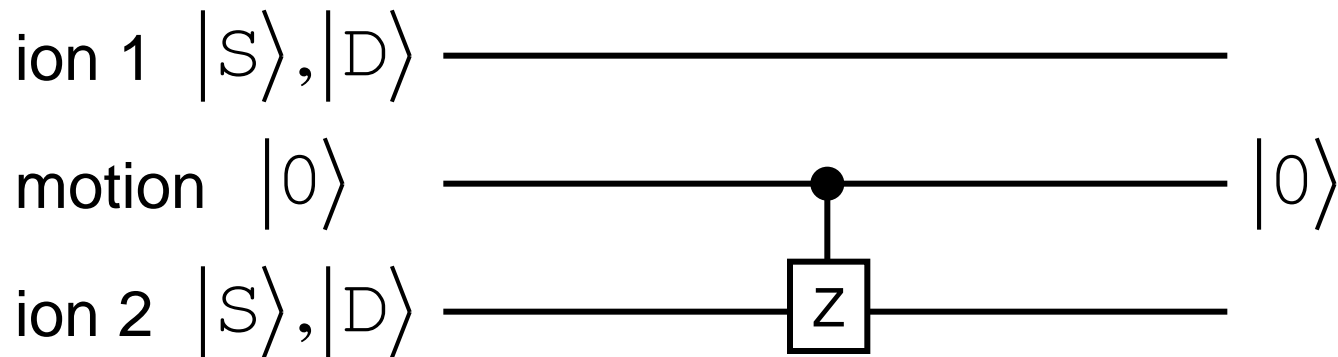

How do you do this with just a two-level system?

$$U_{\Phi} = \begin{matrix} & |D, 0\rangle & |S, 0\rangle & |D, 1\rangle & |S, 1\rangle \\ \begin{pmatrix} 1 & 0 & 0 & 0 \\ 0 & -1 & 0 & 0 \\ 0 & 0 & -1 & 0 \\ 0 & 0 & 0 & ? \end{pmatrix} \end{matrix}$$

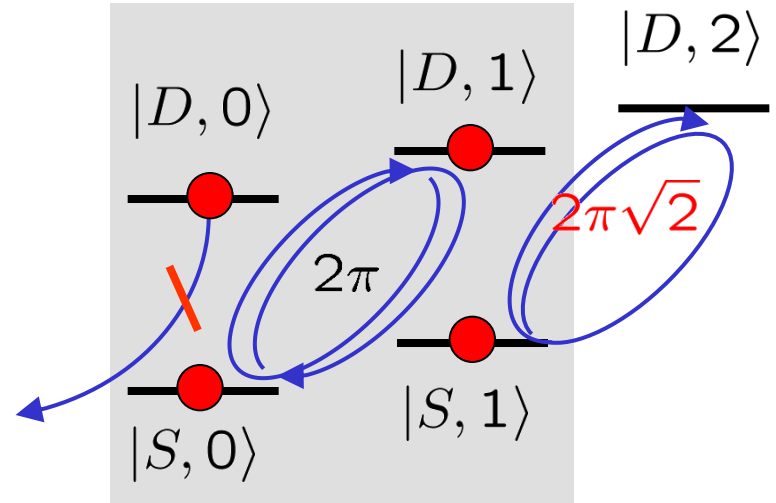

Phase gate

$$U_{\Phi} = \begin{matrix} & |D, 0\rangle & |S, 0\rangle & |D, 1\rangle & |S, 1\rangle \\ \begin{pmatrix} 1 & 0 & 0 & 0 \\ 0 & -1 & 0 & 0 \\ 0 & 0 & -1 & 0 \\ 0 & 0 & 0 & -1 \end{pmatrix} \end{matrix}$$

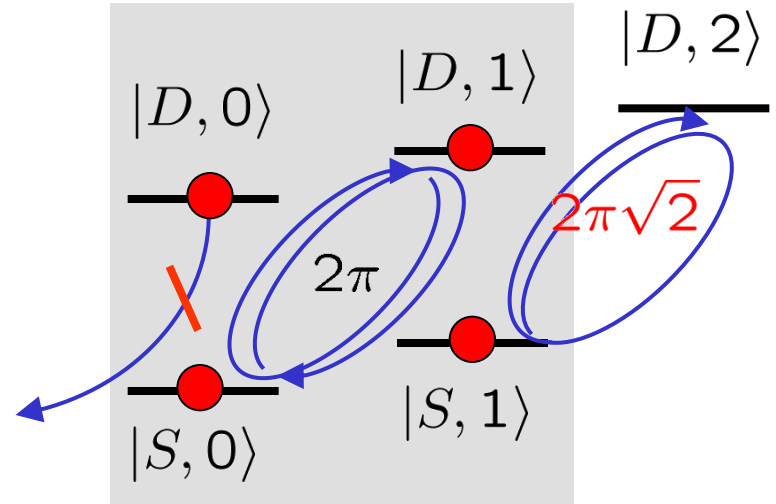

Composite 2π -rotation:

blue	blue	blue	blue
$\pi/\sqrt{2}$	π	$\pi/\sqrt{2}$	π
0	$\pi/2$	0	$\pi/2$

A phase gate with 4 pulses (2π rotation)

$$R(\theta, \phi) = R_1^+(\pi, \pi/2) R_1^+(\pi/\sqrt{2}, 0) R_1^+(\pi, \pi/2) R_1^+(\pi/\sqrt{2}, 0)$$

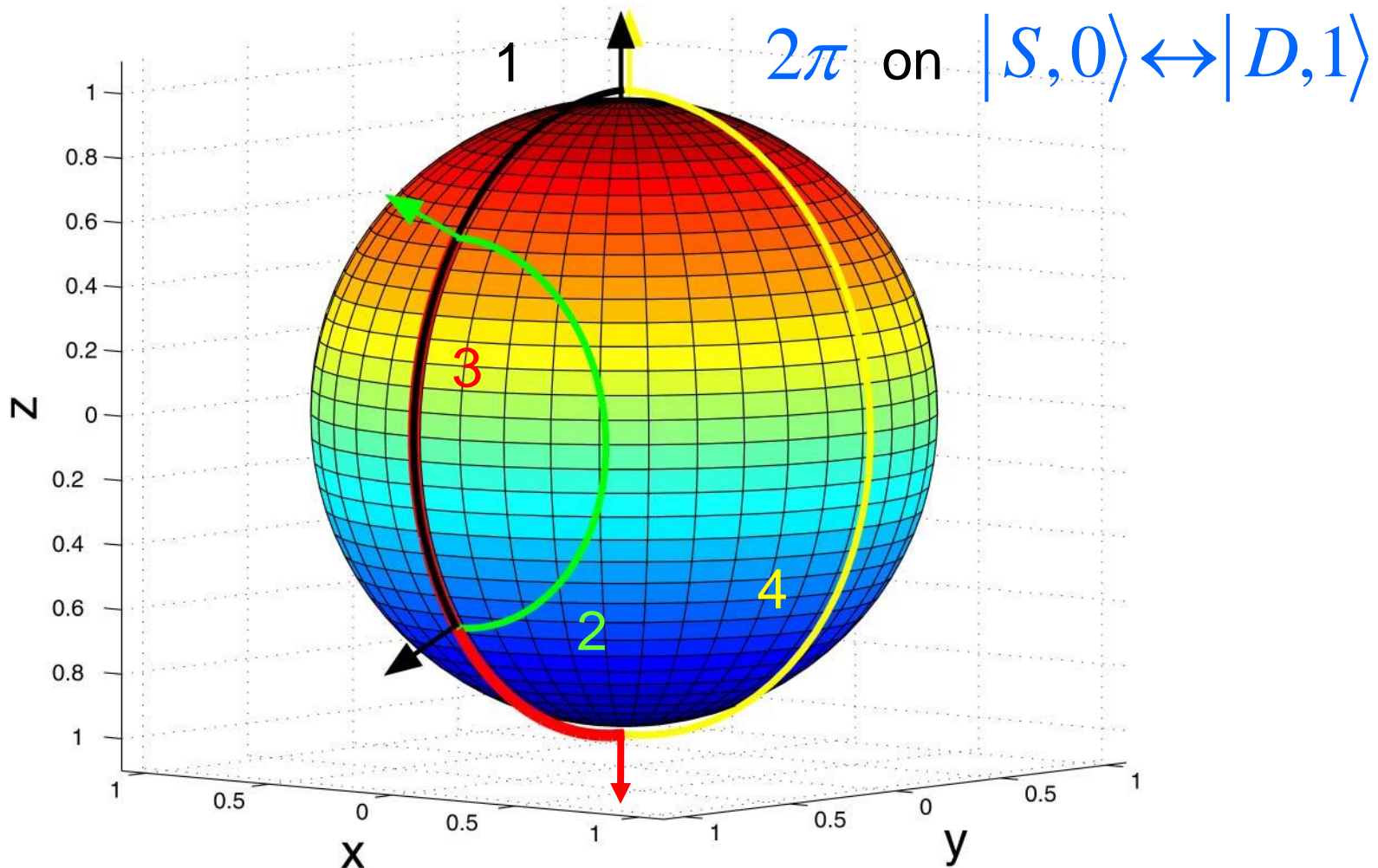

Continuous tomography of the phase gate

A single ion composite phase gate: Experiment

state preparation $|S, 0\rangle$, then application of phase gate pulse sequence

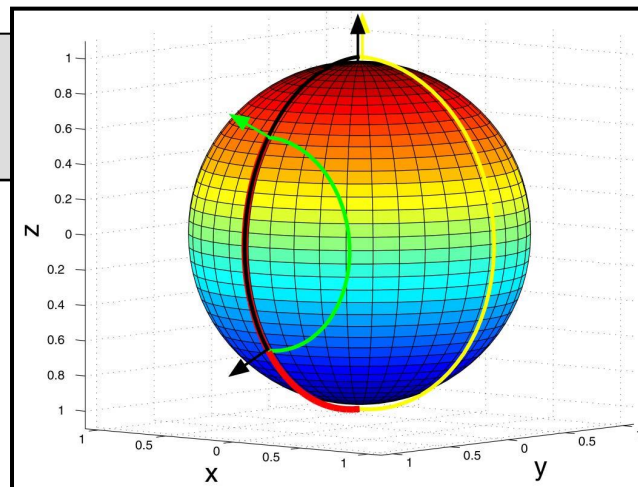
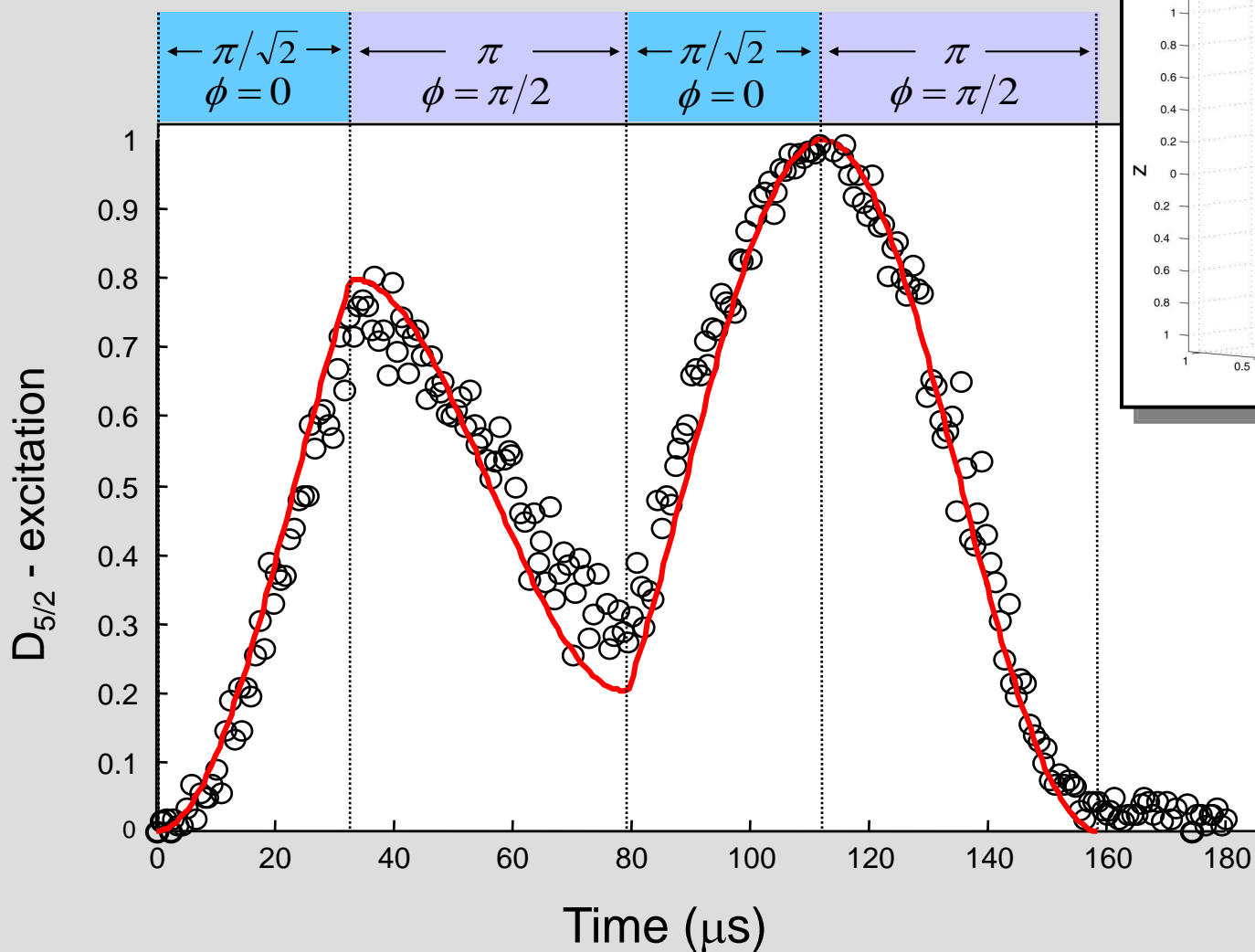

Population of $|S,1\rangle - |D,2\rangle$ remains unaffected

all transition rates are a factor of $\sqrt{2}$ faster at the same Laser power

$$R(\theta, \phi) = R_1^+ \left(\pi\sqrt{2}, \pi/2 \right) R_1^+ \left(\pi, 0 \right) R_1^+ \left(\pi\sqrt{2}, \pi/2 \right) R_1^+ \left(\pi, 0 \right)$$

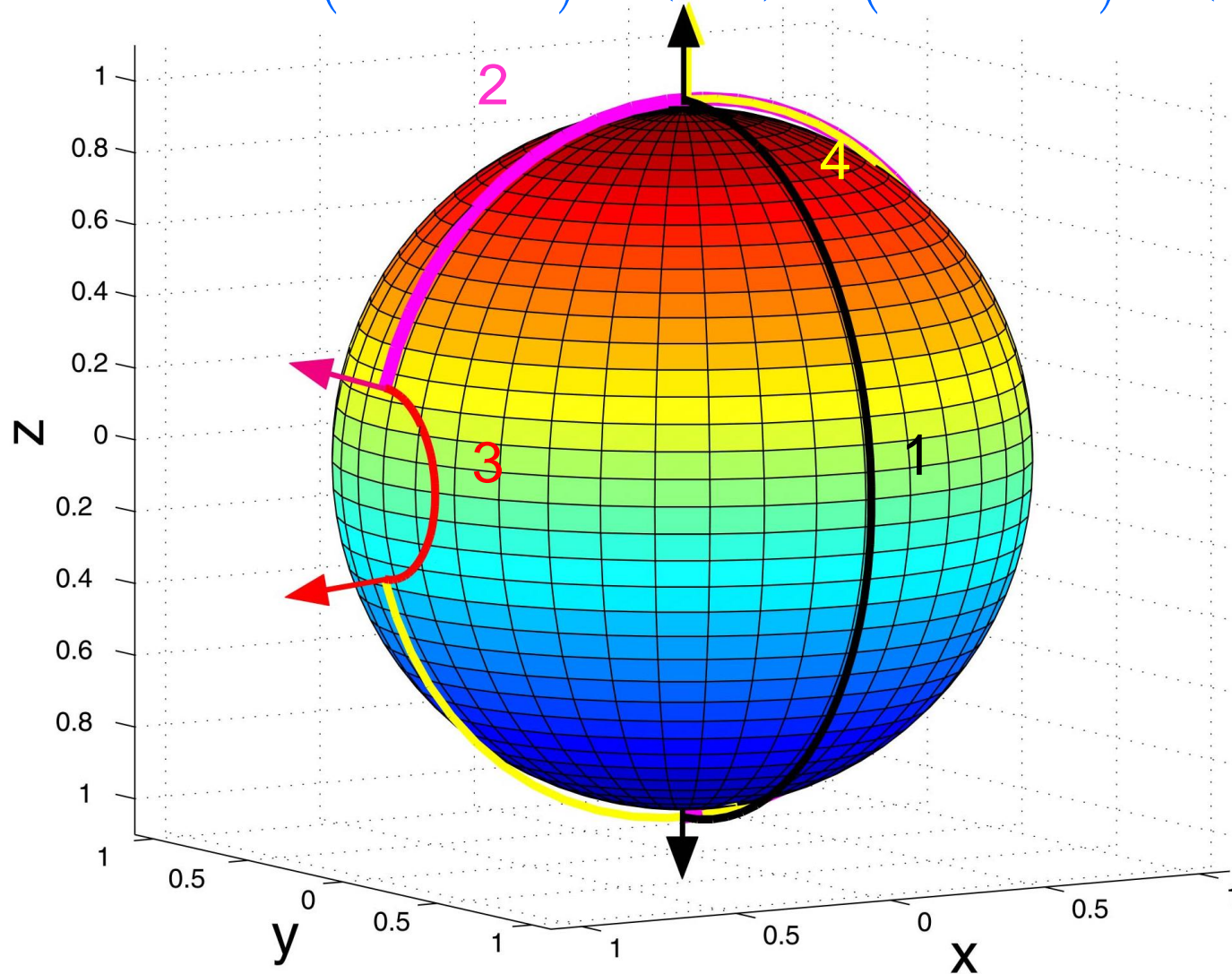

Testing the phase of the phase gate $|0,S\rangle$

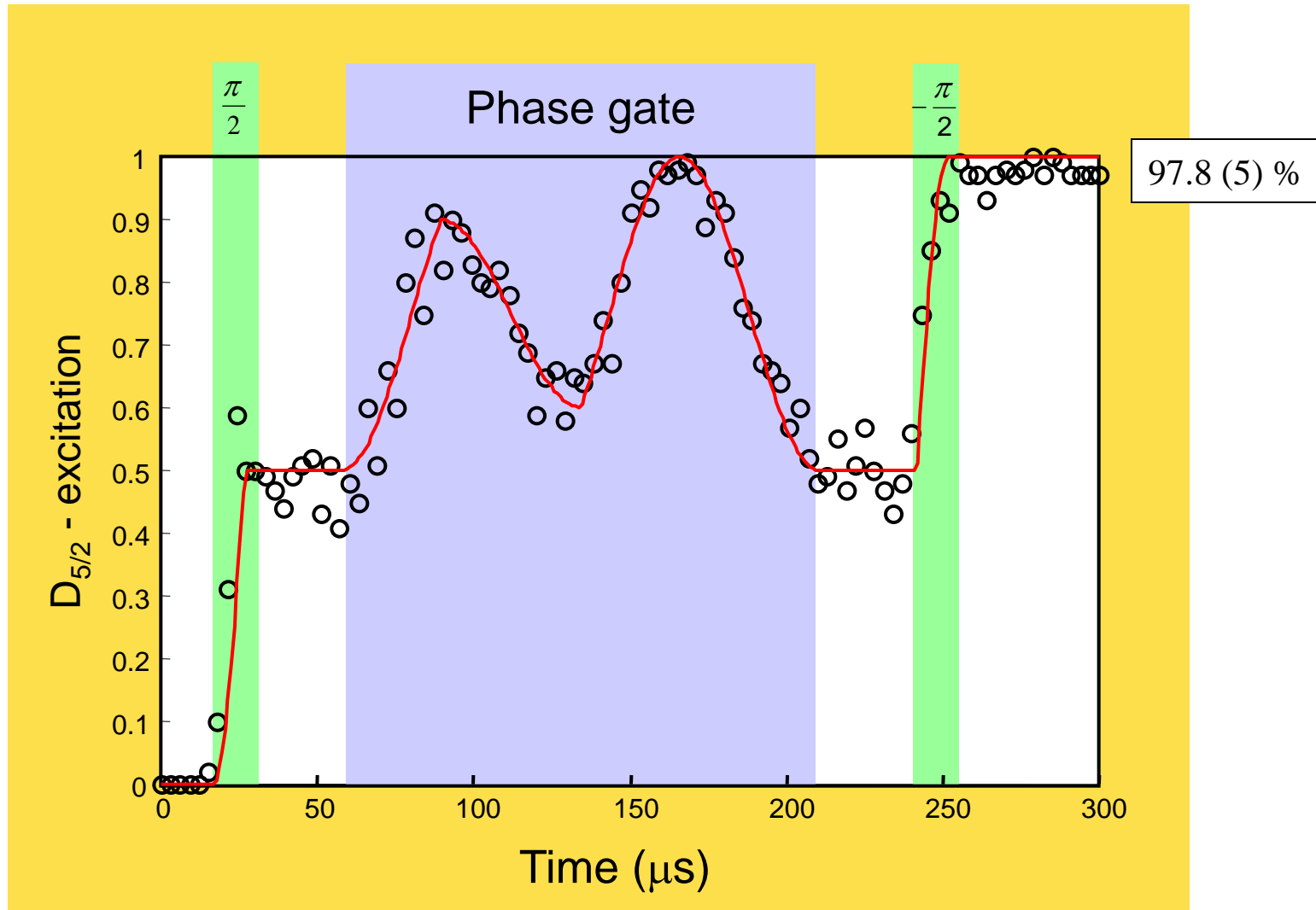

Cirac - Zoller two-ion controlled-NOT operation

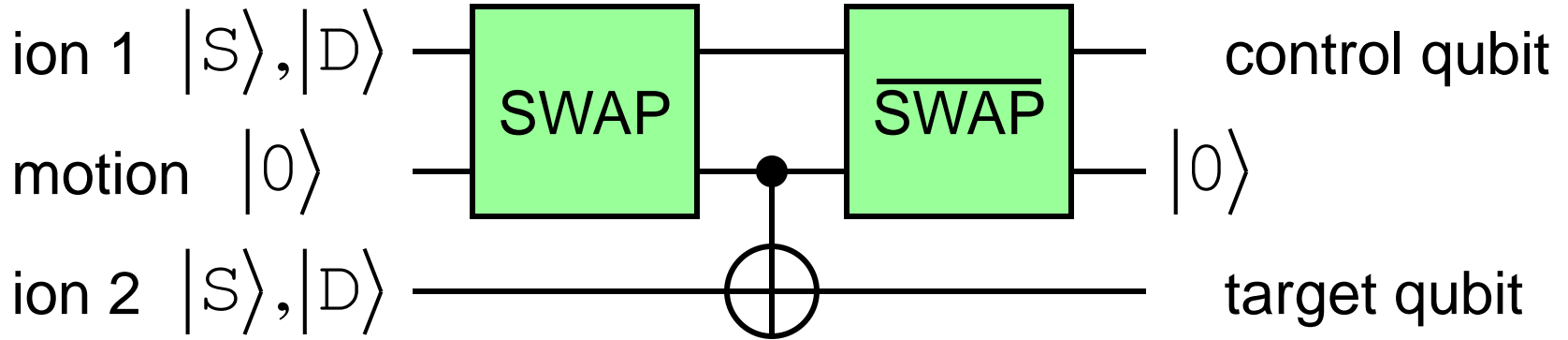

pulse sequence:

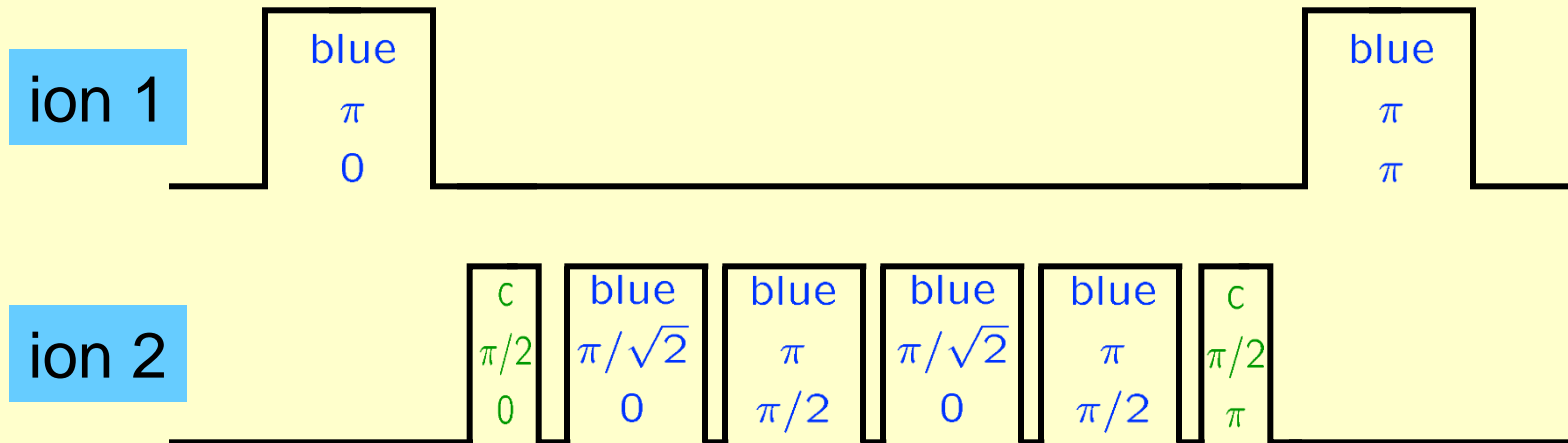

Cirac – Zoller CNOT gate operation

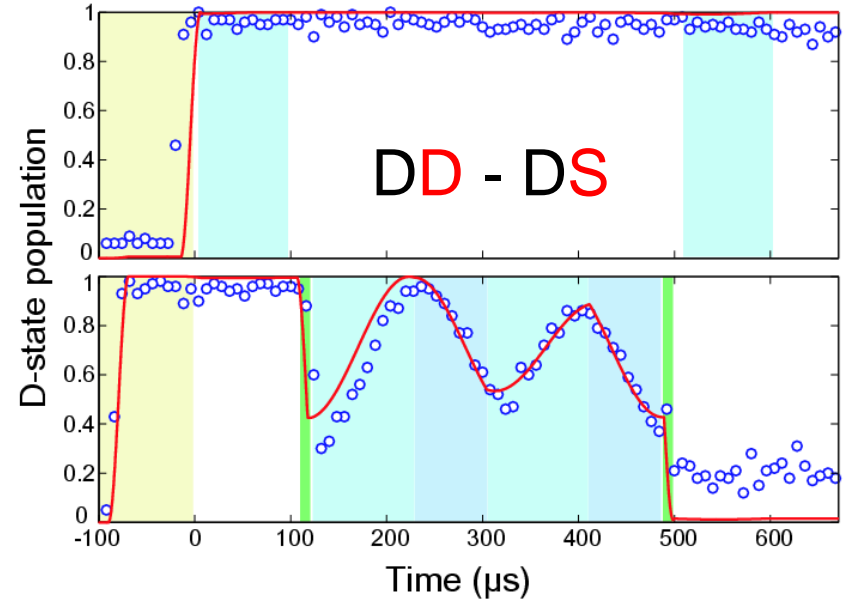
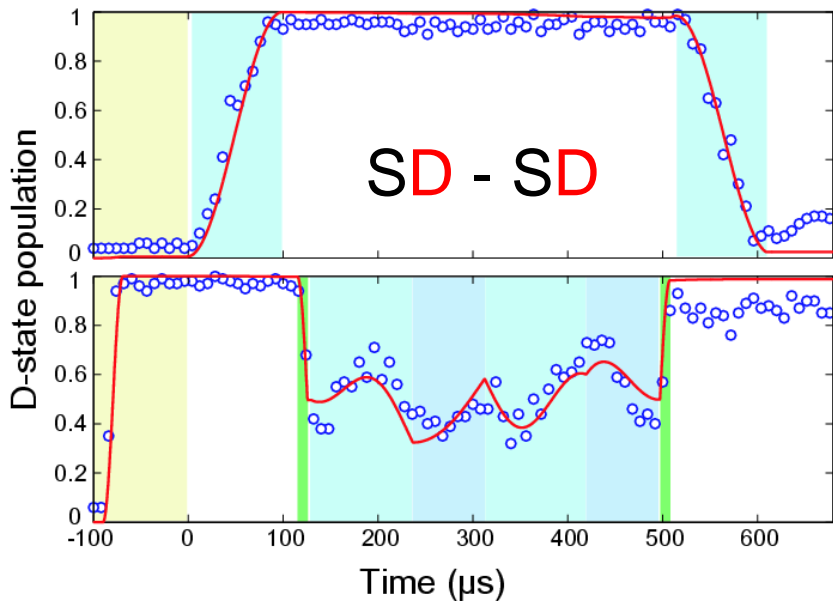
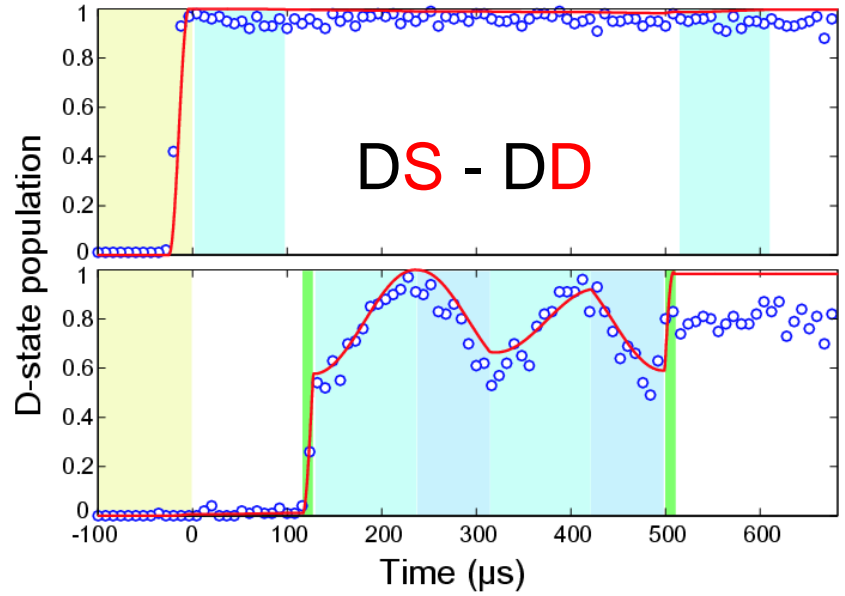
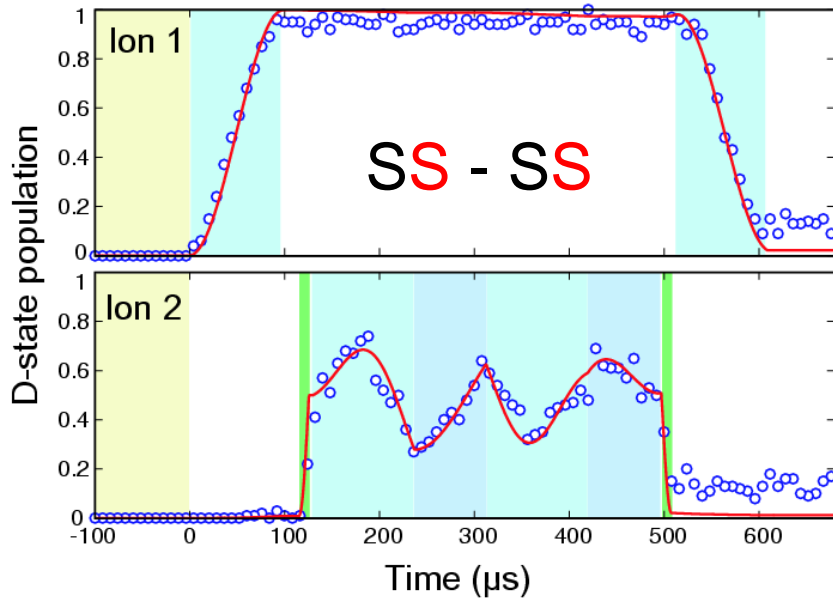

Measured truth table of Cirac-Zoller CNOT operation

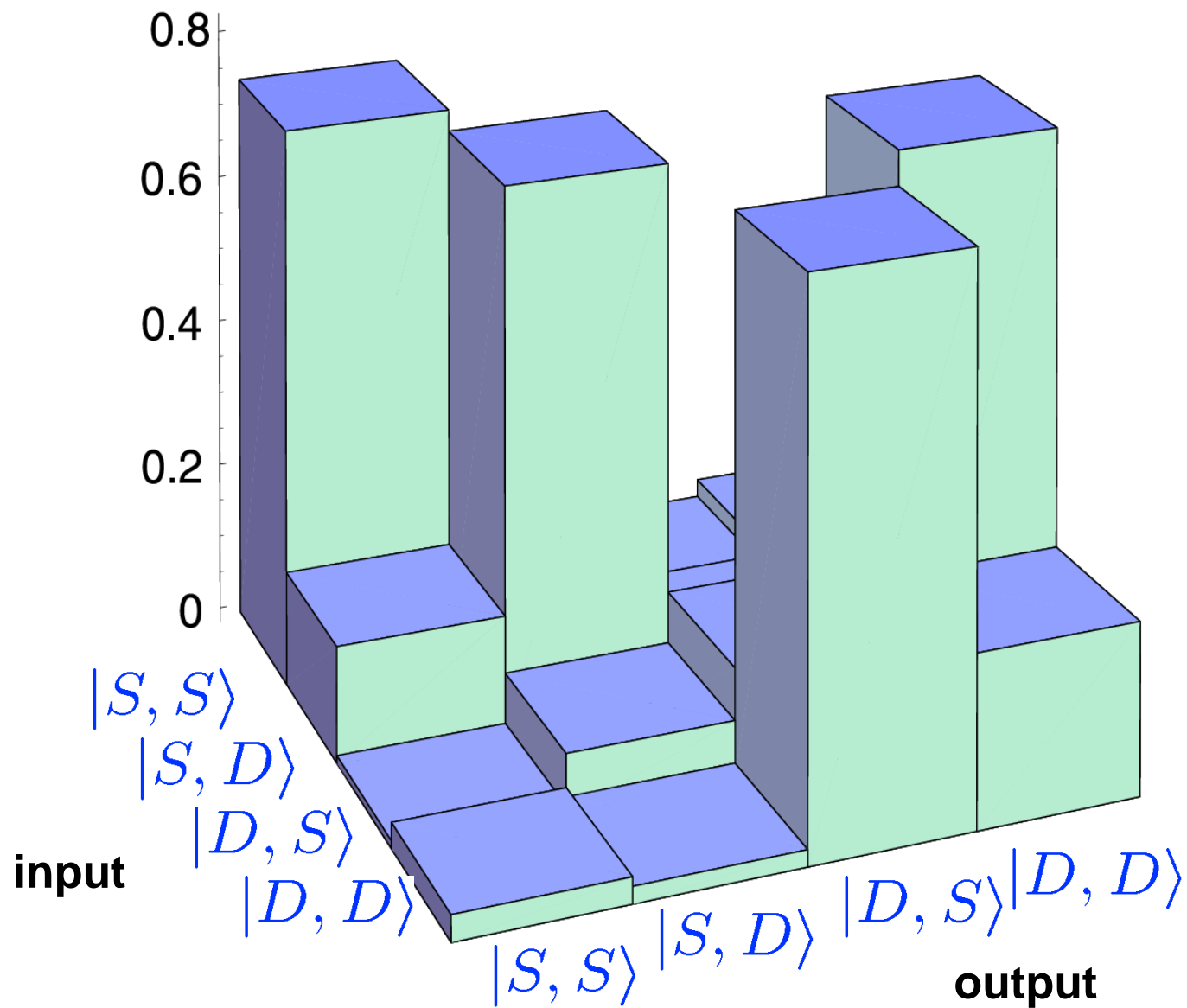

Error budget for Cirac-Zoller CNOT

Error source	Magnitude	Population loss
Laser frequency noise (Phase coherence)	} ~ 100 Hz (FWHM)	~ 10 % !!!
Residual thermal excitation	$\langle n \rangle_{\text{bus}} < 0.02$	2 %
	$\langle n \rangle_{\text{spec}} = 6$	0.4 %
Laser intensity noise	1 % peak to peak	0.1 %
Addressing error (can be corrected for partially)	5 % in Rabi frequency (at neighbouring ion)	3 %
Off resonant excitations	for $t_{\text{gate}} = 600 \mu\text{s}$	4 %
Laser detuning error	~ 500 Hz (FWHM)	~ 2 %
Total	November 2002	~ 20 %