

## Entangled states of trapped atomic ions

Rainer Blatt<sup>1,2</sup> & David Wineland<sup>3</sup>

To process information using quantum-mechanical principles, the states of individual particles need to be entangled and manipulated. One way to do this is to use trapped, laser-cooled atomic ions. Attaining a general-purpose quantum computer is, however, a distant goal, but recent experiments show that just a few entangled trapped ions can be used to improve the precision of measurements. If the entanglement in such systems can be scaled up to larger numbers of ions, simulations that are intractable on a classical computer might become possible.

## Quantum gates in trapped ions

Kristinn Juliusson & Yaroslav Sych

.....

## Realization of the Cirac–Zoller controlled-NOT quantum gate

**Ferdinand Schmidt-Kaler, Hartmut Häffner, Mark Riebe, Stephan Gulde, Gavin P. T. Lancaster, Thomas Deuschle, Christoph Becher, Christian F. Roos, Jürgen Eschner & Rainer Blatt**

*Institut für Experimentalphysik, Universität Innsbruck, Technikerstraße 25, A-6020 Innsbruck, Austria*

.....

# Content

## **Preparation of the Qubit:**

- Ion Paul traps
- Laser cooling
- Qubit states and detection

## **Two Qubit Gates:**

- Cirac-Zoller Gate
- Phase gate
- Mølmer–Sørensen gate

## **Conclusion**

# Ion Paul traps

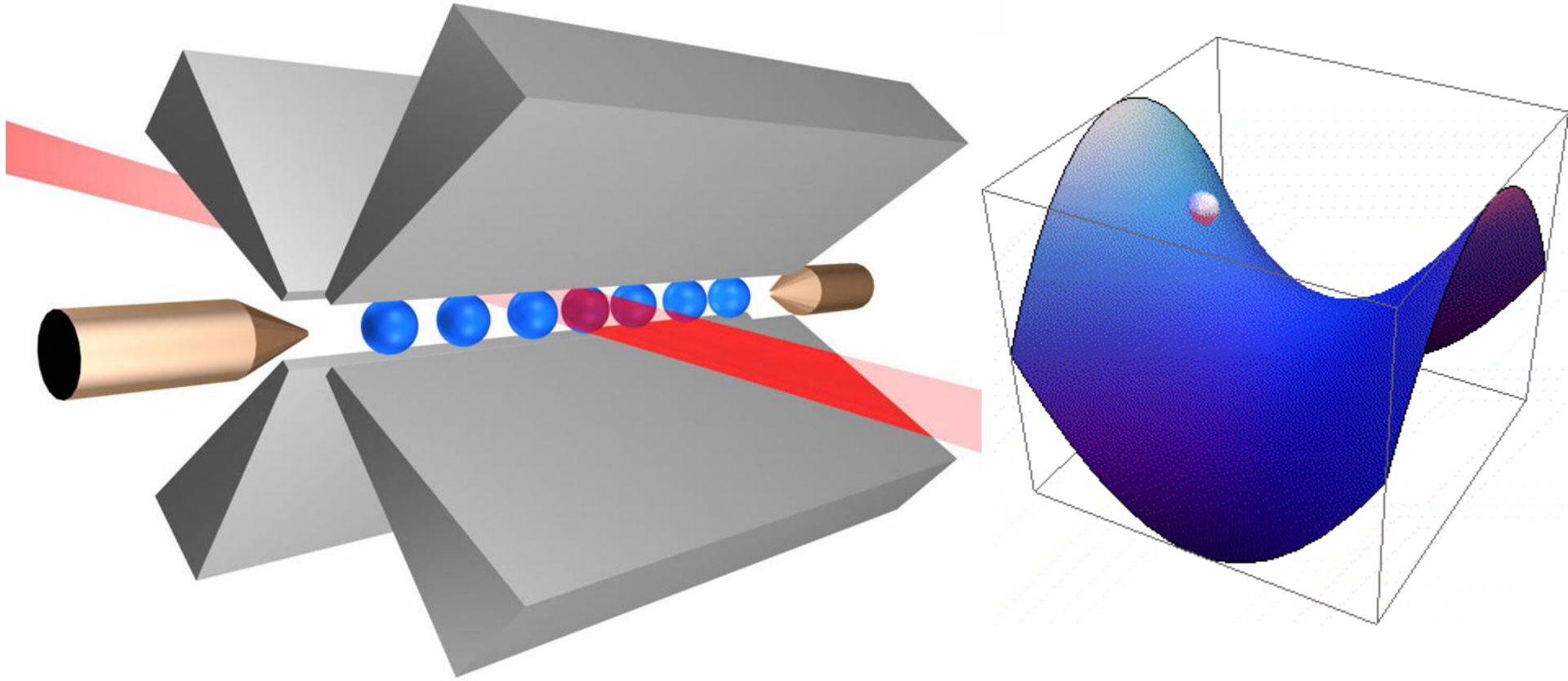

- A charge acted on by electrostatic forces can not rest in a stable equilibrium in an electric field.
- $\Phi = \Phi_0 + (V_0/2r_0^2) \cos(\omega t)(x^2 - y^2)$

# Ion Paul traps

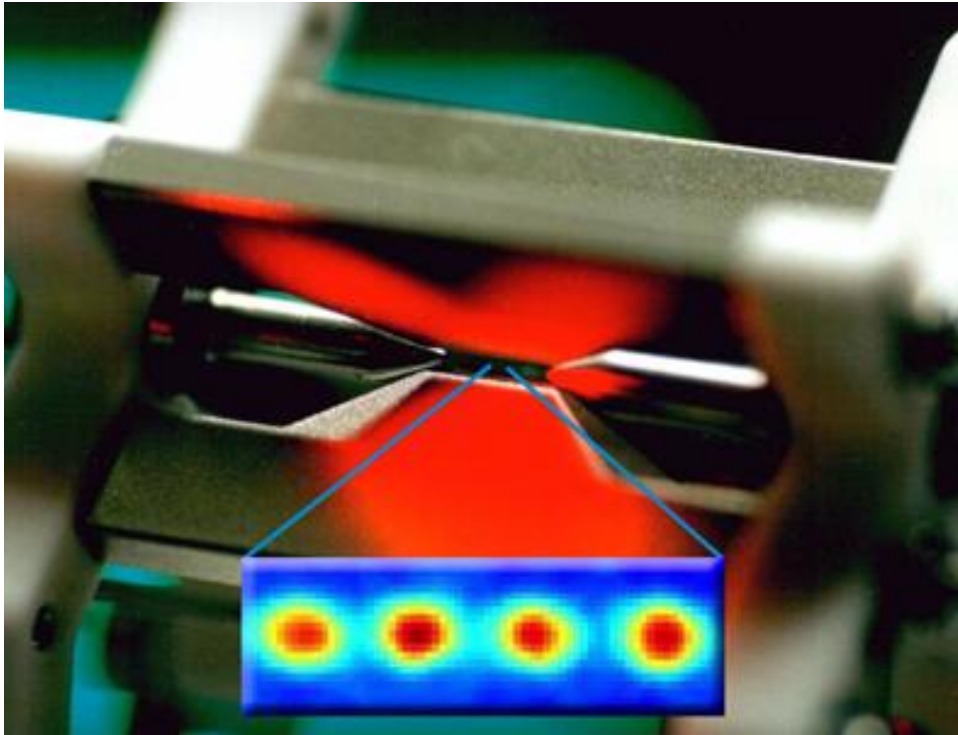

$^{40}\text{Ca}^+$  ions

Harmonic trap

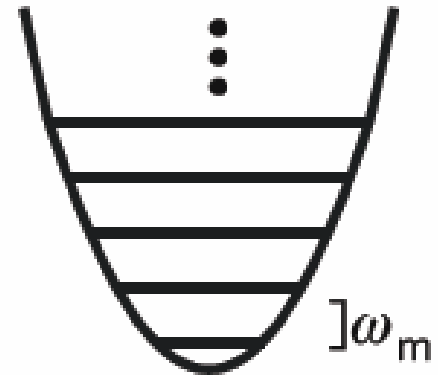

- Analogy : harmonic oscillator potential and equally spaced energy levels.

# Laser cooling

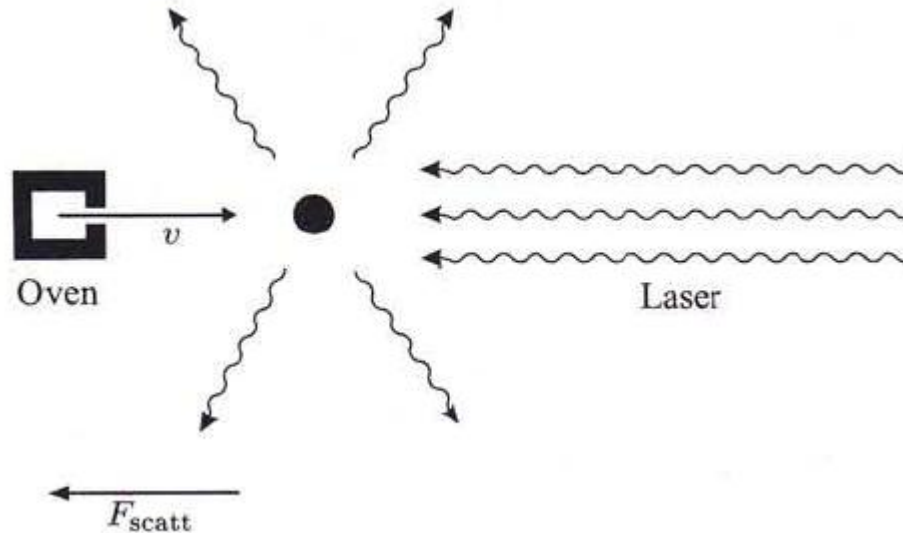

$F_{\text{scatt}} = (\text{photon momentum}) \times (\text{scattering rate})$

$$R_{\text{scatt}} = \frac{\Gamma}{2} \cdot \frac{\Omega^2/2}{2 \cdot \delta^2 + \Omega^2/2 + \Gamma^2/4}$$

$$\delta = \omega - \omega_0 + k \cdot v$$

**COOLING OF GASES BY LASER RADIATION<sup>1\*</sup>**

T.W. HÄNSCH<sup>2†</sup> and A.L. SCHAWLOW

*Department of Physics, Stanford University, Stanford, California 94305, USA*

Received 20 October 1974

# Laser cooling

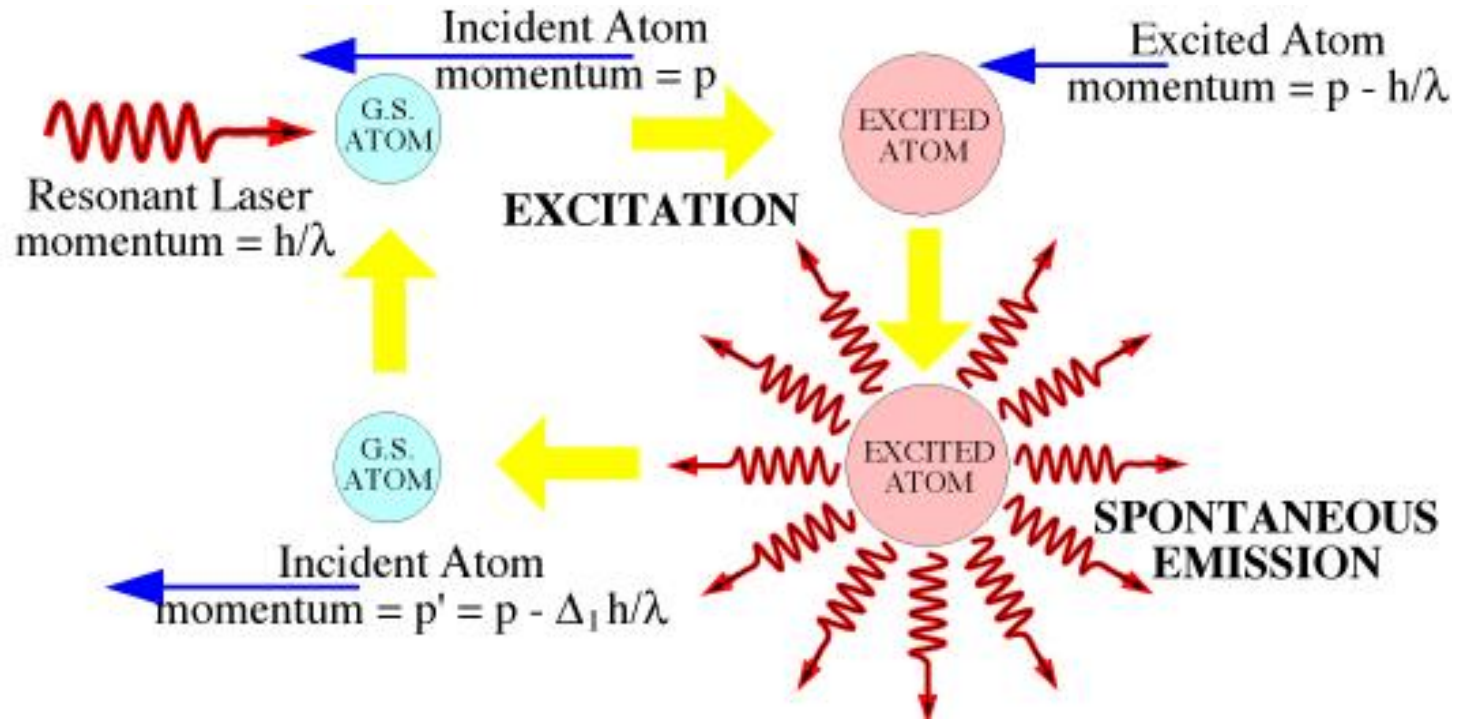

$$F_{\text{scatt}} = (\text{photon momentum}) \times (\text{scattering rate})$$

COOLING OF GASES BY LASER RADIATION<sup>1\*</sup>

T.W. HÄNSCH<sup>2†</sup> and A.L. SCHAWLOW

*Department of Physics, Stanford University, Stanford, California 94305, USA*

Received 20 October 1974

# Single Qubit

- The ion's ground state  $g$  and excited state  $e$ ,  $S_{1/2} - D_{5/2}$  interacts with radiation characterized by the Rabi frequency  $\Omega$ .

- Coupling of spin and motional degrees of freedom (e.g.  $|g, n\rangle \rightarrow |e, n+\Delta n\rangle$  [ $\Delta n = \pm 1, 0$ ])

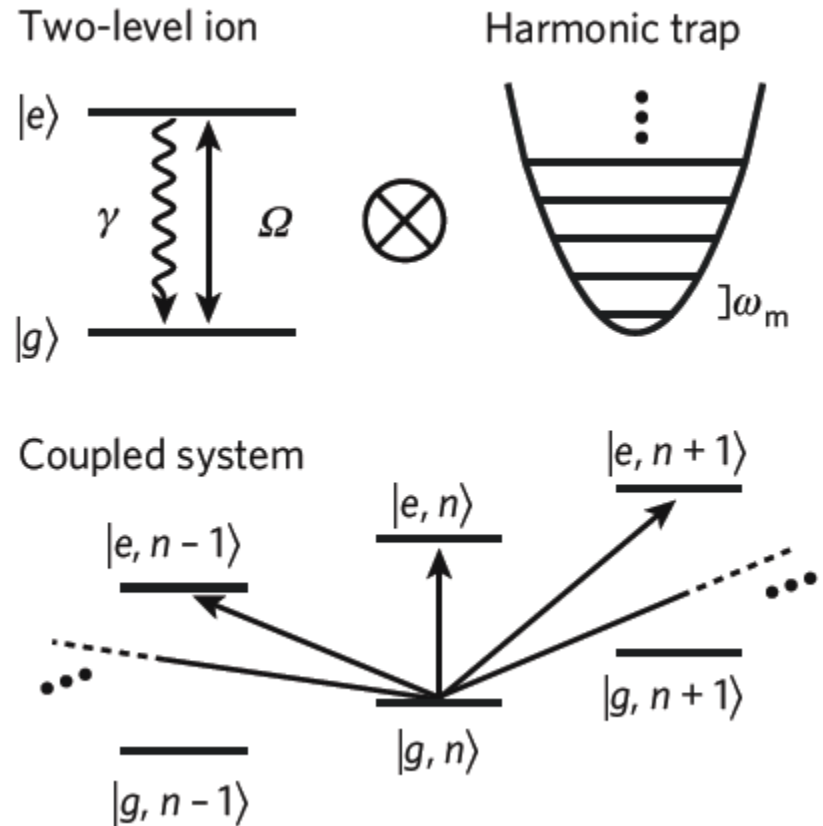

# Qubit state measurement

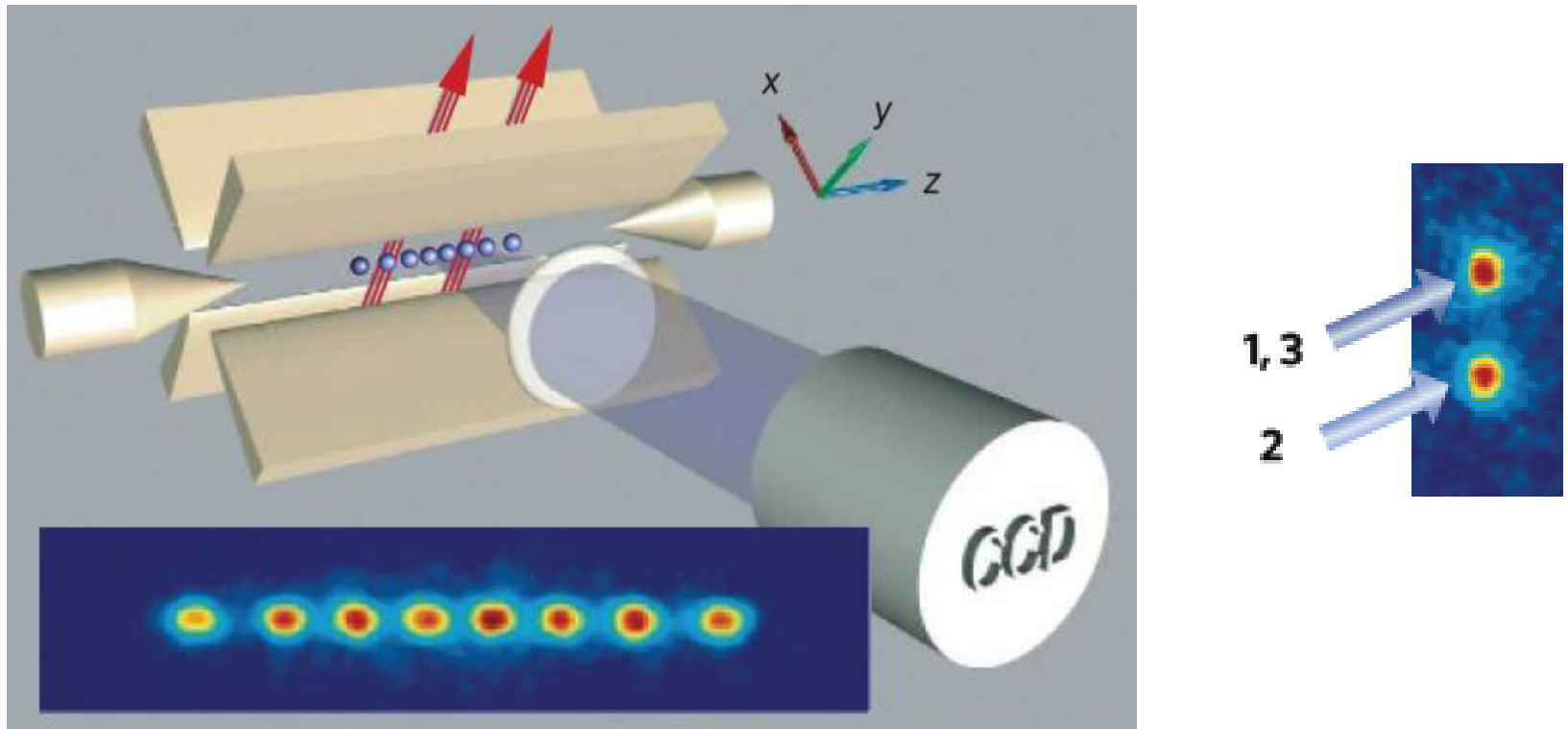

Qubit state of an ion can be detected by fluorescence measurement from an auxiliary state  $S_{1/2}$ - $P_{3/2}$



# Two Qubit Gates:

## Various ways to entangle

- Cirac-Zoller gate
  - Entanglement of two qubits via sting mode
- Phase gate
  - State dependant phase switching
- Mølmer–Sørensen gate
  - Entangling with simultaneous irradiation

# Cirac-Zoller Gate

- $R_{\Delta n}(\theta, \varphi) = \cos(\theta/2)|g, n\rangle + ie^{i\varphi}\sin(\theta/2)|e, n+\Delta n\rangle$

- $R_{\Delta n}(\theta, \varphi) = ie^{-i\varphi}\sin(\theta/2)|g, n\rangle + \cos(\theta/2)|e, n+\Delta n\rangle$

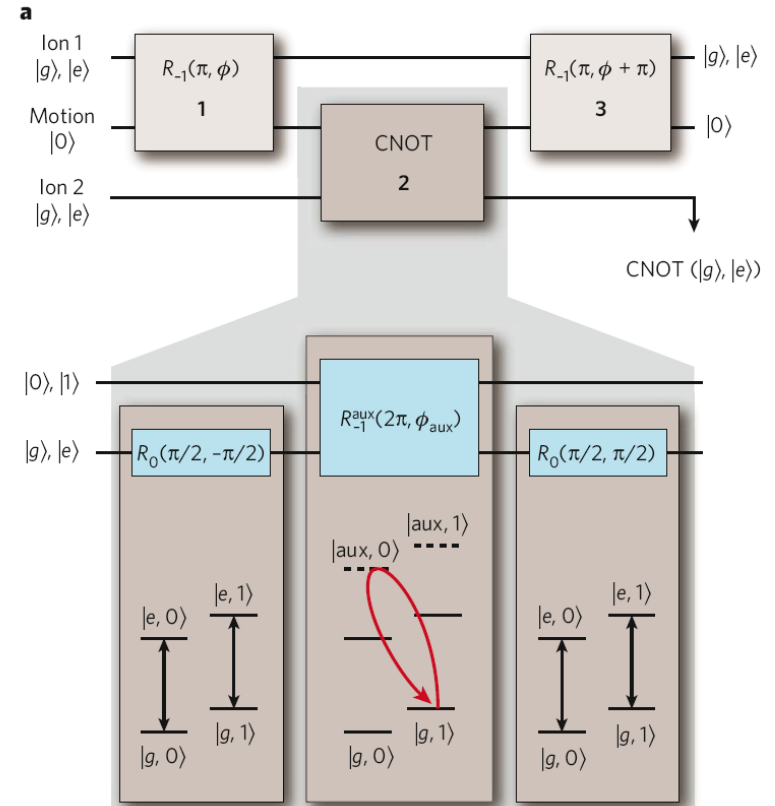

# Implementation in $^{40}\text{Ca}^+$

- Implemented in S1/2 ground state and metastable D5/2 state (lifetime  $t < 1$  s)

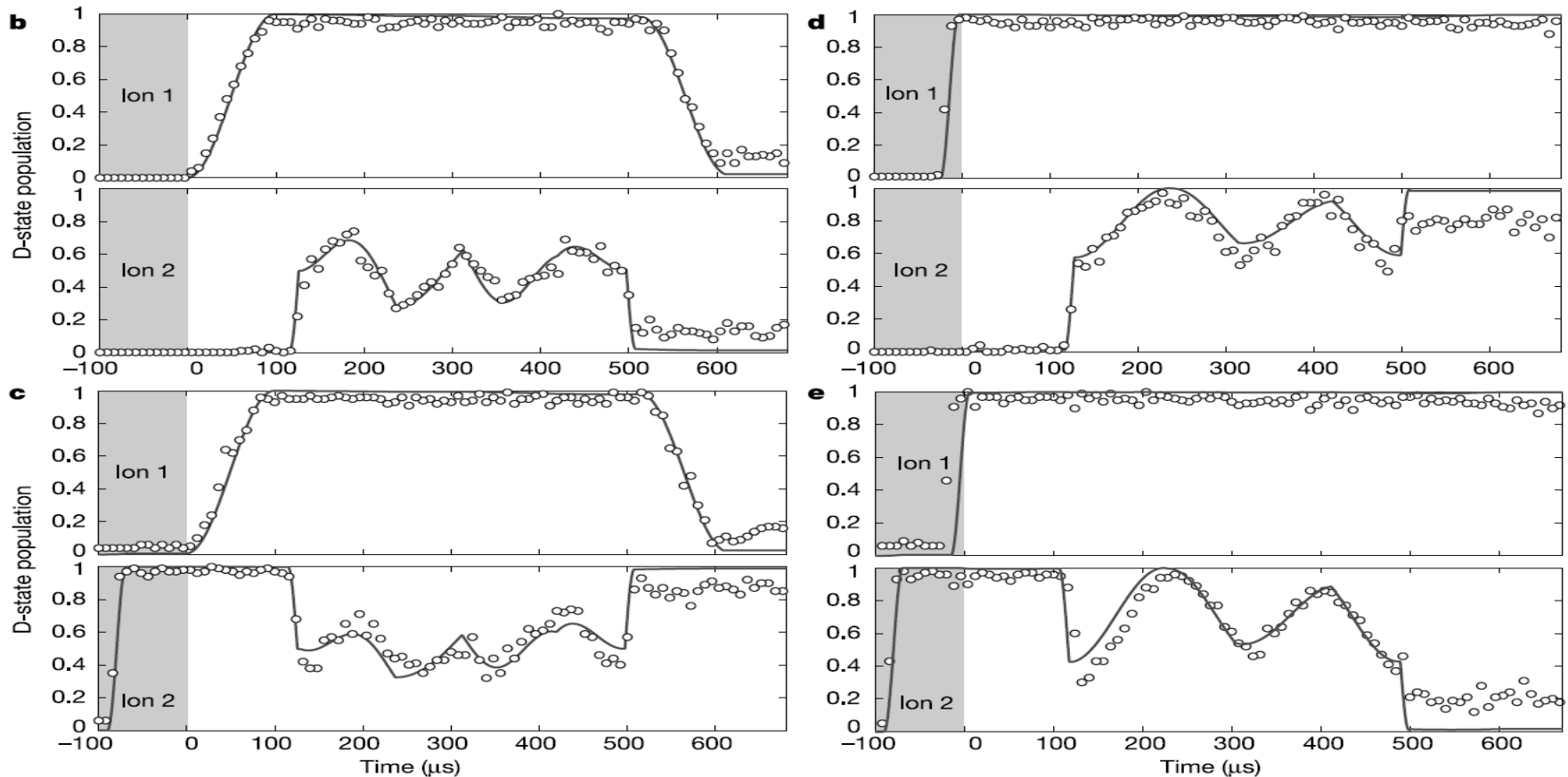

# Mølmer-Sørensen Gate

- Entanglement mediated through the common vibrational mode
- Simultaneous spin flips
- Yields fidelity  $F=99.2(1)\%$

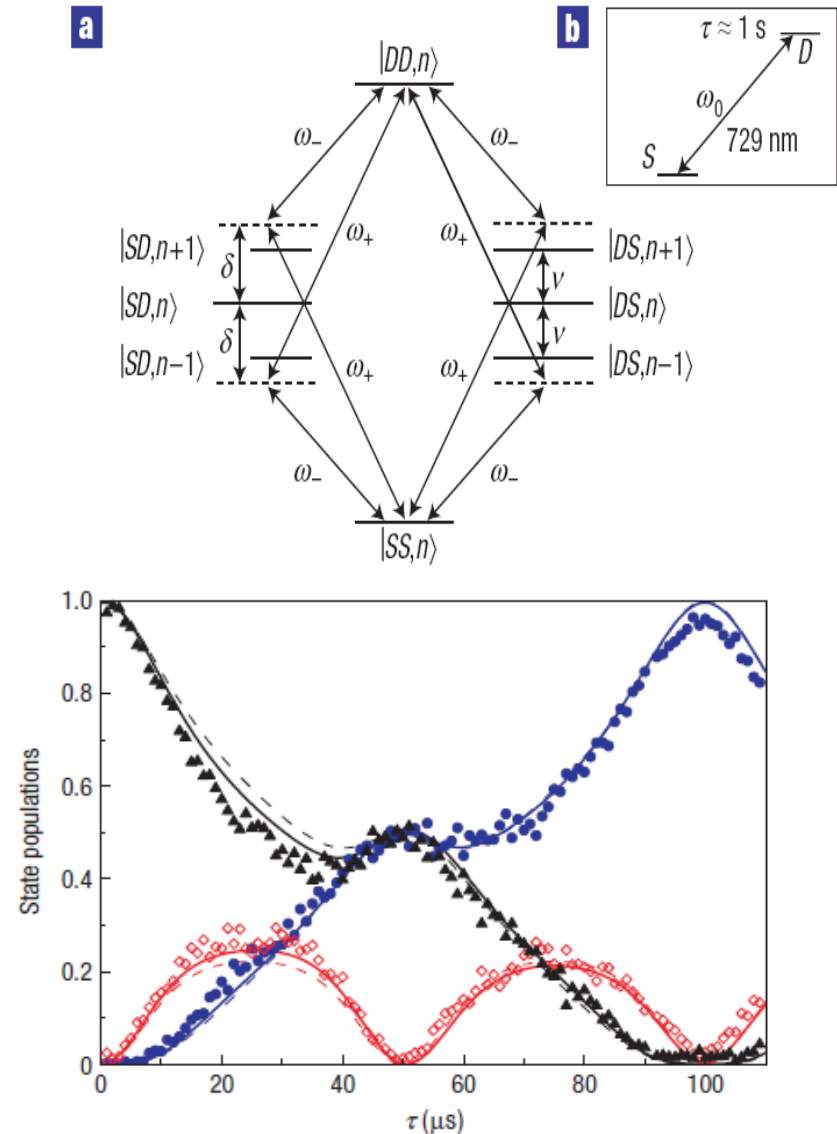

# Conclusions

- Fidelity Threshold: two qubit gates
  - Cirac-Zoller, Mølmer–Sørensen.
- Trapped Ions are the most promising candidate for error correction.