

2.7.5 Entanglement

Definition: An **entangled state** of a composite system is a state that cannot be written as a product state of the component systems.

example: an entangled 2-qubit state (one of the Bell states)

$$|\psi\rangle = \frac{1}{\sqrt{2}} (|00\rangle + |11\rangle)$$

What is special about this state? Try to write it as a product state!

$$|\psi_1\rangle = \alpha_1 |0\rangle + \beta_1 |1\rangle ; |\psi_2\rangle = \alpha_2 |0\rangle + \beta_2 |1\rangle$$

$$|\psi_1 \psi_2\rangle = \alpha_1 \alpha_2 |00\rangle + \alpha_1 \beta_2 |01\rangle + \beta_1 \alpha_2 |10\rangle + \beta_1 \beta_2 |11\rangle$$

$$|\psi\rangle \stackrel{!}{=} |\psi_1 \psi_2\rangle \Rightarrow \alpha_1 \alpha_2 = \frac{1}{\sqrt{2}} \wedge \beta_1 \beta_2 = \frac{1}{\sqrt{2}} \Rightarrow \alpha_1, \beta_2 \neq 0$$

$$\wedge \alpha_2, \beta_1 \neq 0!$$

It is not possible! This state is special, it is entangled!

Use this property as a resource in quantum information processing:

- super dense coding
- teleportation
- error correction

2.7.5 Measurement of a single qubit in an entangled state

$$|\psi\rangle = \frac{1}{\sqrt{2}} (|00\rangle + |11\rangle)$$

measurement of first qubit:

$$P_1(0) = \langle\psi| (M_0 \otimes I)^\dagger (M_0 \otimes I) |\psi\rangle = \frac{1}{\sqrt{2}} \langle 00| \frac{1}{\sqrt{2}} |00\rangle = \frac{1}{2}$$

post measurement state:

$$|\psi'\rangle = \frac{(M_0 \otimes I) |\psi\rangle}{\sqrt{P_1(0)}} = \frac{\frac{1}{\sqrt{2}} |00\rangle}{\frac{1}{\sqrt{2}}} = |00\rangle$$

measurement of qubit two will then result with certainty in the same result:

$$P_2(0) = \langle\psi'| (I \otimes M_0)^\dagger (I \otimes M_0) |\psi'\rangle = 1$$

The two measurement results are **correlated!**

- Correlations in quantum systems can be stronger than correlations in classical systems.
- This can be generally proven using the **Bell inequalities** which will be discussed later.
- Make use of such correlations as a **resource** for information processing
 - super dense coding, teleportation, error corrections

2.7.6 Super Dense Coding

task: Try to transmit two bits of classical information between Alice (A) and Bob (B) using only one qubit.

- As Alice and Bob are living in a quantum world they are allowed to use one pair of entangled qubits that they have prepared ahead of time.

protocol:

A) Alice and Bob each have one qubit of an entangled pair in their possession

$$|\psi\rangle = \frac{1}{\sqrt{2}} (|00\rangle + |11\rangle)$$

B) Alice does a quantum operation on her qubit depending on which 2 classical bits she wants to communicate

C) Alice sends her qubit to Bob

D) Bob does one measurement on the entangled pair



shared entanglement

local operations

send Alice's qubit to Bob

Bob measures

$$\frac{1}{\sqrt{2}} |00\rangle + \frac{1}{\sqrt{2}} |11\rangle$$

$$X, Y, Z, I$$



bits to be transferred:

Alice's operation

resulting 2-qubit state

Bob's measurement

00

I_1

$$I_1 |\psi\rangle = \frac{1}{\sqrt{2}} (|00\rangle + |11\rangle)$$

01

Z_1

$$Z_1 |\psi\rangle = \frac{1}{\sqrt{2}} (|00\rangle - |11\rangle)$$

10

X_1

$$X_1 |\psi\rangle = \frac{1}{\sqrt{2}} (|10\rangle + |01\rangle)$$

11

iY_1

$$iY_1 |\psi\rangle = \frac{1}{\sqrt{2}} (|10\rangle - |01\rangle)$$

measure in Bell basis

- all these states are entangled (try!)
- they are called the Bell states

comments:

- two qubits are involved in protocol BUT Alice only interacts with one and sends only one along her quantum communications channel
- two bits cannot be communicated sending a single classical bit along a classical communications channel

original proposal of super dense coding: [Charles H. Bennett and Stephen J. Wiesner, Communication via one- and two-particle operators on Einstein-Podolsky-Rosen states, Phys. Rev. Lett. 69, 2881\(1992\)](#)

2.7.7 Experimental demonstration of super dense coding using photons

Generating polarization entangled photon pairs using **Parametric Down Conversion**:

parametric down-conversion

- 1 UV-photon \rightarrow 2 "red" photons
- conservation of energy $\omega_p = \omega_s + \omega_i$
- conservation of momentum $\vec{k}_p = \vec{k}_s + \vec{k}_i$
- Polarisationskorrelationen (typ II)

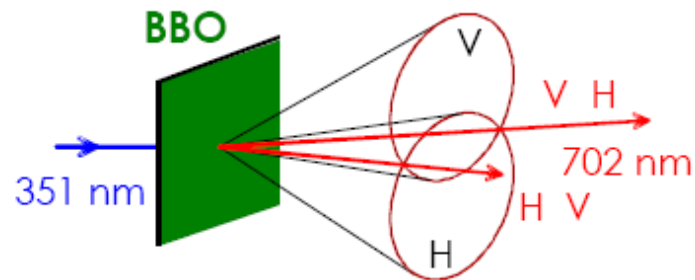

$$|\Psi^-\rangle = \frac{1}{\sqrt{2}}(|H\rangle|V\rangle - |V\rangle|H\rangle)$$

optically nonlinear
medium: BBO
(BaB₂O₄)
beta barium borate

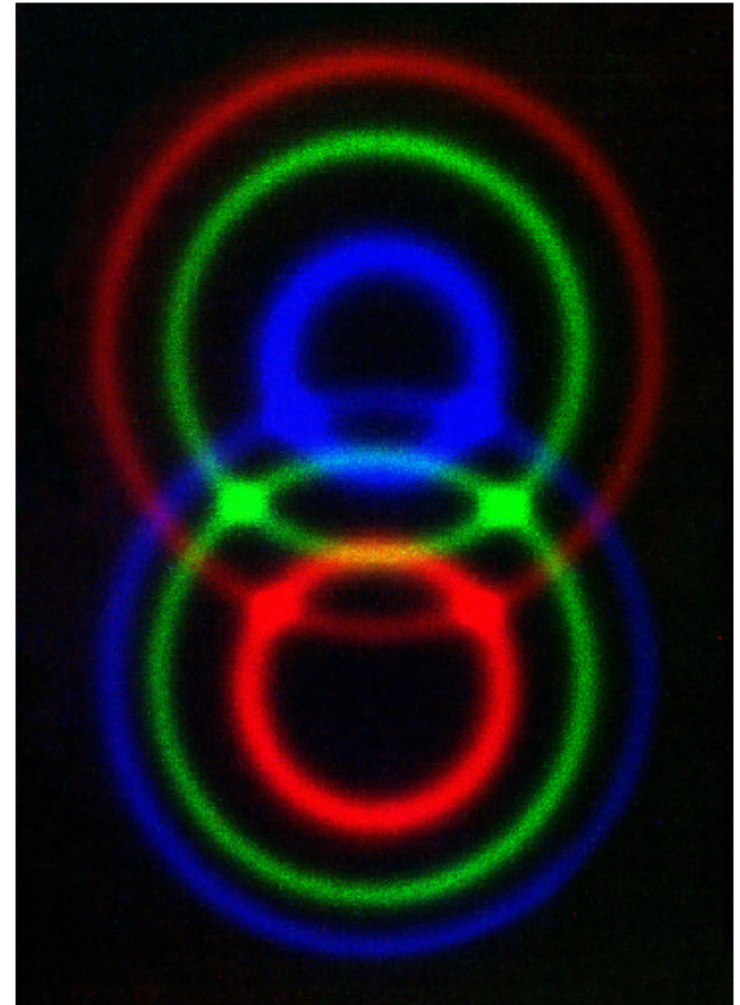

state manipulation

Bell state measurement

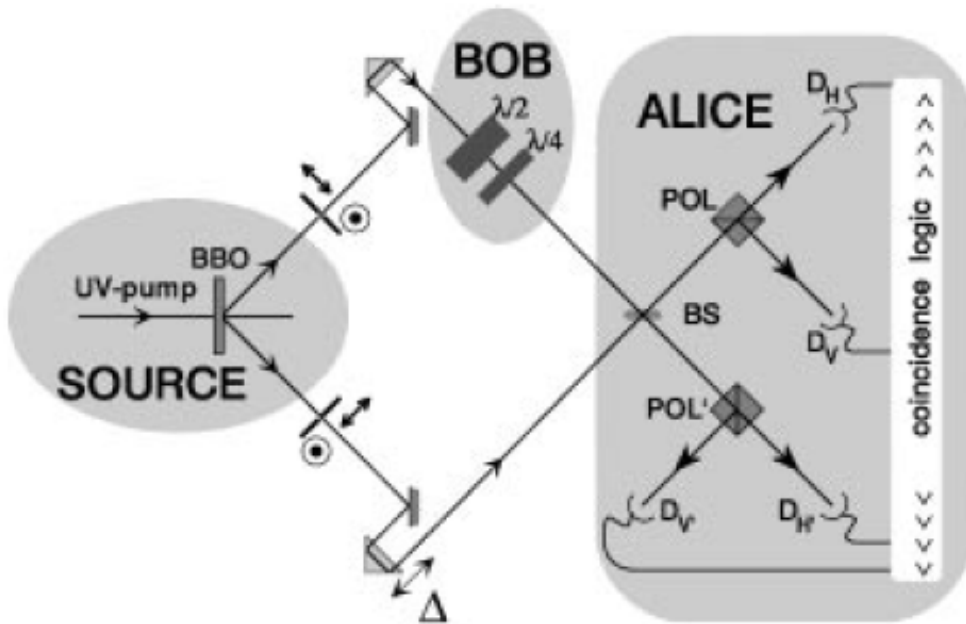

$$\begin{aligned} \Psi^- &= \frac{1}{\sqrt{2}} (|HV\rangle - |VH\rangle) && \text{asym.} \\ \Psi^+ &= \frac{1}{\sqrt{2}} (|HV\rangle + |VH\rangle) \\ \Phi^+ &= \frac{1}{\sqrt{2}} (|HH\rangle + |VV\rangle) && \text{sym.} \\ \Phi^- &= \frac{1}{\sqrt{2}} (|HH\rangle - |VV\rangle) \end{aligned}$$

H = horizontal polarization
V = vertical polarization

[Klaus Mattle](#), [Harald Weinfurter](#), [Paul G. Kwiat](#), and [Anton Zeilinger](#), Dense coding in experimental quantum communication, [Phys. Rev. Lett.76, 4656 \(1996\)](#)

2.8 Two Qubit Quantum Logic Gates

2.8.1 The controlled NOT gate (CNOT)

function:

$$\begin{aligned} |00\rangle &\longrightarrow |00\rangle \\ |01\rangle &\longrightarrow |01\rangle \\ |10\rangle &\longrightarrow |11\rangle \\ |11\rangle &\longrightarrow |10\rangle \end{aligned}$$

$$|A, B\rangle \longrightarrow |A, A \oplus B\rangle \quad \text{addition mod 2 of basis states}$$

CNOT circuit:



comparison with classical gates:

- XOR is not reversible
- CNOT is reversible (unitary)

Universality of controlled NOT:

Any multi qubit logic gate can be composed of CNOT gates and single qubit gates X,Y,Z.

2.8.2 Application of CNOT: generation of entangled states (Bell states)

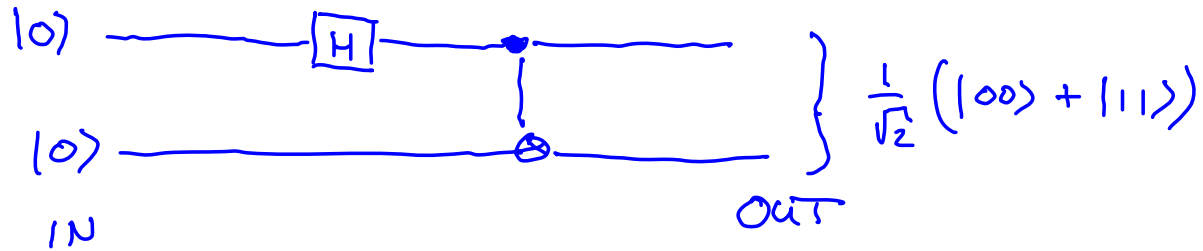

$$|00\rangle \xrightarrow{H_1} \frac{1}{\sqrt{2}}(|00\rangle + |10\rangle) \xrightarrow{\text{CNOT}} \frac{1}{\sqrt{2}}(|00\rangle + |11\rangle)$$

$$|01\rangle \xrightarrow{H_1} \frac{1}{\sqrt{2}}(|01\rangle + |11\rangle) \xrightarrow{\text{CNOT}} \frac{1}{\sqrt{2}}(|01\rangle + |10\rangle)$$

$$|10\rangle \xrightarrow{H_1} \frac{1}{\sqrt{2}}(|00\rangle - |10\rangle) \xrightarrow{\text{CNOT}} \frac{1}{\sqrt{2}}(|00\rangle - |11\rangle)$$

$$|11\rangle \xrightarrow{H_1} \frac{1}{\sqrt{2}}(|01\rangle - |11\rangle) \xrightarrow{\text{CNOT}} \frac{1}{\sqrt{2}}(|01\rangle - |10\rangle)$$

exercise: Write down the unitary matrix representations of the CNOT in the computational basis with qubit 1 being the control qubit. Write down the matrix in the same basis with qubit 2 being the control bit.

2.8.3 Implementation of CNOT using the Ising interaction

Ising interaction:

$$H = - \sum_{ij} J_{ij} \hat{z}_i \hat{z}_j$$

pair wise spin interaction

generic two-qubit interaction:

$$H = -J \hat{z}_1 \hat{z}_2$$

$J > 0$: ferromagnetic coupling

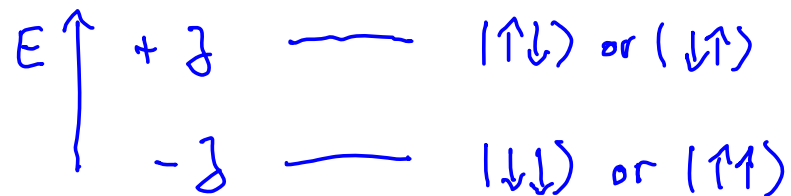

$J < 0$: anti-ferrom. coupling

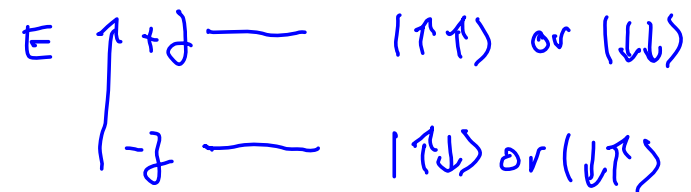

2-qubit unitary evolution:

$$C(\gamma) = e^{-i \frac{\gamma}{2} \hat{z}_1 \hat{z}_2}$$

BUT this does not realize a CNOT gate yet. Additionally, single qubit operations on each of the qubits are required to realize a CNOT gate.

CNOT realization with the Ising-type interaction

CNOT - unitary:

$$C_{NOT} = e^{-i \frac{3\pi}{4}} R_{X_2} \left(\frac{3\pi}{2} \right) C \left(\frac{3\pi}{2} \right) R_{Z_2} \left(\frac{\pi}{2} \right) R_{X_2} \left(\frac{\pi}{2} \right) R_{Z_2} \left(\frac{\pi}{2} \right) R_{Z_1} \left(\frac{\pi}{2} \right) C \left(\frac{3\pi}{2} \right)$$

circuit representation:

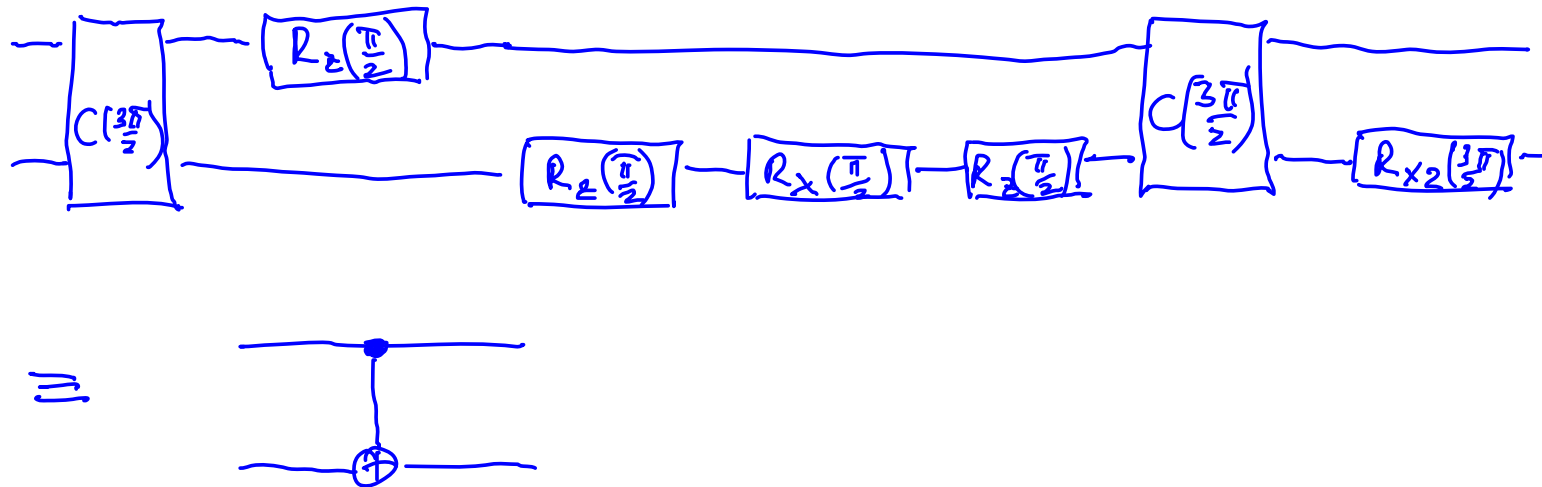

Any physical two-qubit interaction that can produce entanglement can be turned into a universal two-qubit gate (such as the CNOT gate) when it is augmented by arbitrary single qubit operations.

Bremner et al., *Phys. Rev. Lett.* **89**, 247902 (2002)

2.9 Quantum Teleportation

Task: Alice wants to transfer an unknown quantum state ψ to Bob only using **one entangled pair** of qubits and **classical information** as a resource.

note:

- Alice does not know the state to be transmitted
- Even if she knew it the classical amount of information that she would need to send would be infinite.

The **teleportation circuit:**

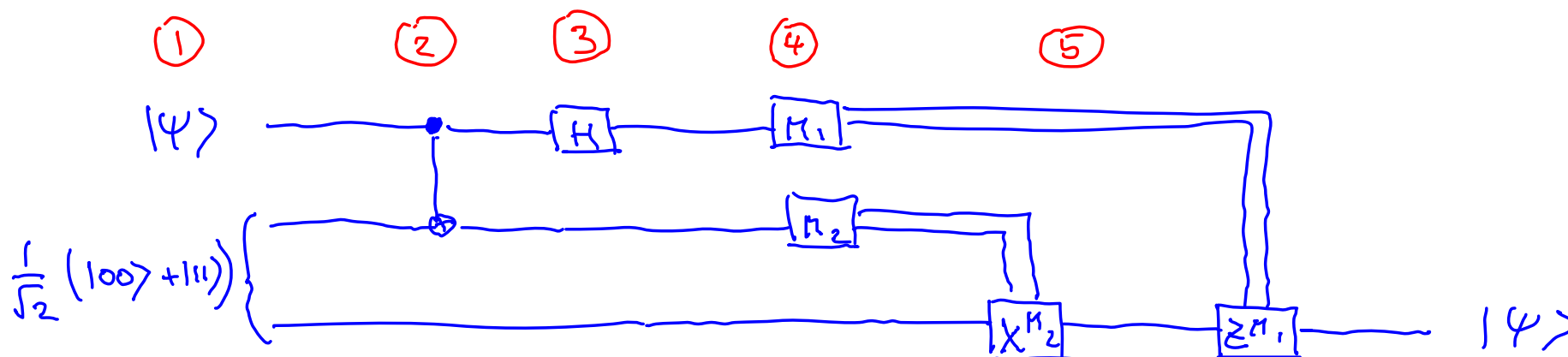

original article: [Bennett, C. H. et al., Teleporting an unknown quantum state via dual classical and Einstein-Podolsky-Rosen channels, *Phys. Rev. Lett.* **70**, 1895-1899 \(1993\)](#)

2.9.1 How does it work?

$$\textcircled{1} \quad |\psi\rangle \otimes \frac{1}{\sqrt{2}} (|00\rangle + |11\rangle) = \frac{1}{\sqrt{2}} (\alpha |000\rangle + \alpha |011\rangle + \beta |100\rangle + \beta |111\rangle)$$

CNOT between qubit to be teleported and one bit of the entangled pair:

$$\textcircled{2} \quad \xrightarrow{\text{CNOT}_{12}} \frac{1}{\sqrt{2}} (\alpha |000\rangle + \alpha |011\rangle + \beta |110\rangle + \beta |101\rangle)$$

Hadamard on qubit to be teleported:

$$\textcircled{3} \quad \xrightarrow{H_1} \frac{1}{2} \left[(|00\rangle (\alpha |0\rangle + \beta |1\rangle) + |10\rangle (\alpha |0\rangle - \beta |1\rangle) + |01\rangle (\alpha |1\rangle + \beta |0\rangle) + |11\rangle (\alpha |1\rangle - \beta |0\rangle) \right]$$

measurement of qubit 1 and 2, classical information transfer and single bit manipulation on target qubit 3:

$$\textcircled{4} \quad \xrightarrow{M_1 \otimes M_2} \begin{array}{l} P_{00} = \frac{1}{4} \quad ; \quad |\psi_3\rangle = \alpha |0\rangle + \beta |1\rangle \xrightarrow{H} |\psi\rangle \\ P_{10} = \frac{1}{4} \quad ; \quad |\psi_3\rangle = \alpha |0\rangle - \beta |1\rangle \xrightarrow{Z} |\psi\rangle \\ P_{01} = \frac{1}{4} \quad ; \quad |\psi_3\rangle = \alpha |1\rangle + \beta |0\rangle \xrightarrow{X} |\psi\rangle \\ P_{11} = \frac{1}{4} \quad ; \quad |\psi_3\rangle = \alpha |1\rangle - \beta |0\rangle \xrightarrow{XZ} |\psi\rangle \end{array}$$

2.9.2 (One) Experimental Realization of Teleportation using Photon Polarization:

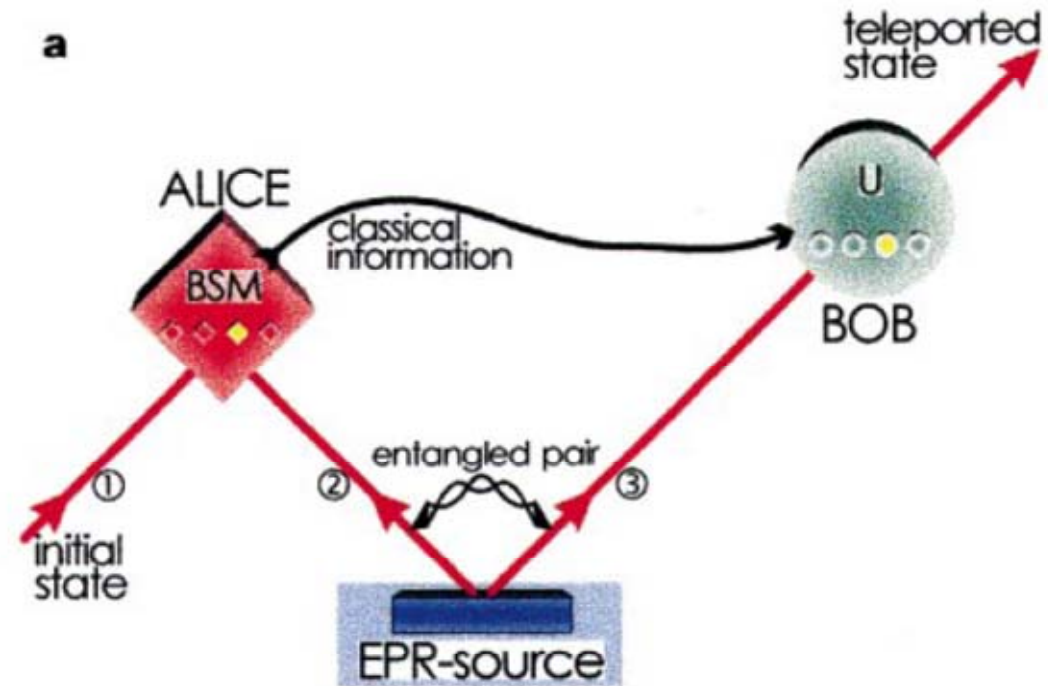
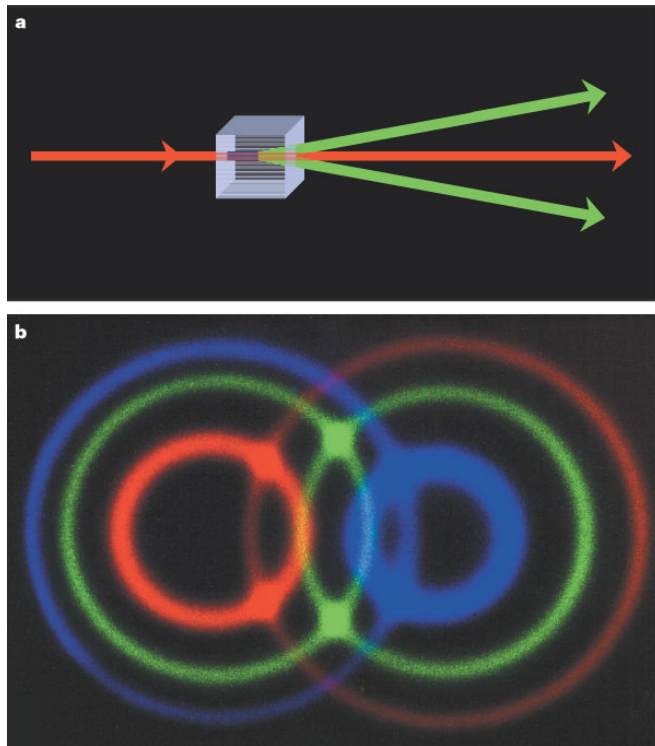

- parametric down conversion (PDC)
source of entangled photons
- qubits are polarization encoded

Dik Bouwmeester, Jian-Wei Pan, Klaus Mattle, Manfred Eibl, Harald Weinfurter, Anton Zeilinger, Experimental quantum teleportation *Nature* **390**, 575 (1997)

Experimental Implementation

start with states

$$|\psi_1\rangle = \alpha |H\rangle + \beta |V\rangle$$

$$|\psi_{23}\rangle = \frac{1}{\sqrt{2}} (|HV\rangle - |VH\rangle)$$

combine photon to be teleported (1) and one photon of entangled pair (2) on a 50/50 beam splitter (BS) and measure (at Alice) resulting state in Bell basis.

analyze resulting teleported state of photon (3) using polarizing beam splitters (PBS) single photon detectors

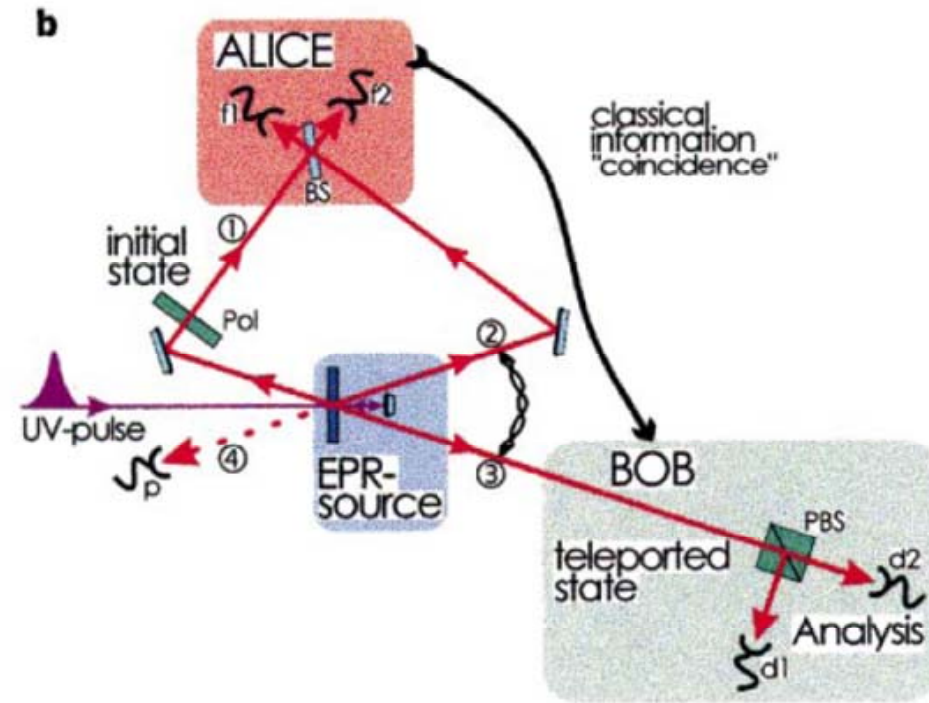

- polarizing beam splitters (PBS) as detectors of teleported states

teleportation papers for you to present:

[Experimental Realization of Teleporting an Unknown Pure Quantum State via Dual Classical and Einstein-Podolsky-Rosen Channels](#)

[D. Boschi](#), [S. Branca](#), [F. De Martini](#), [L. Hardy](#), and [S. Popescu](#)

Phys. Rev. Lett. **80**, 1121 (1998) [[PROLA Link](#)]

Unconditional Quantum Teleportation

A. Furusawa, J. L. Sørensen, S. L. Braunstein, C. A. Fuchs, H. J. Kimble, and E. S. Polzik

Science 23 October 1998 282: 706-709 [DOI: 10.1126/science.282.5389.706] (in Research Articles)

[Abstract](#) » [Full Text](#) » [PDF](#) »

Complete quantum teleportation using nuclear magnetic resonance

M. A. Nielsen, E. Knill, R. Laflamme

Nature 396, 52 - 55 (05 Nov 1998) Letters to Editor

[Abstract](#) | [Full Text](#) | [PDF](#) | [Rights and permissions](#) | [Save this link](#)

Deterministic quantum teleportation of atomic qubits

M. D. Barrett, J. Chiaverini, T. Schaetz, J. Britton, W. M. Itano, J. D. Jost, E. Knill, C. Langer, D. Leibfried, R. Ozeri, D. J. Wineland

Nature 429, 737 - 739 (17 Jun 2004) Letters to Editor

[Abstract](#) | [Full Text](#) | [PDF](#) | [Rights and permissions](#) | [Save this link](#)

Deterministic quantum teleportation with atoms

M. Riebe, H. Haeffner, C. F. Roos, W. Haensel, J. Benhelm, G. P. T. Lancaster, T. W. Koerber, C. Becher, F. Schmidt-Kaler, D. F. V. James, R. Blatt

Nature 429, 734 - 737 (17 Jun 2004) Letters to Editor

[Abstract](#) | [Full Text](#) | [PDF](#) | [Rights and permissions](#) | [Save this link](#)

Quantum teleportation between light and matter

Jacob F. Sherson, Hanna Krauter, Rasmus K. Olsson, Brian Julsgaard, Klemens Hammerer, Ignacio Cirac, Eugene S. Polzik

Nature 443, 557 - 560 (05 Oct 2006) Letters to Editor

[Full Text](#) | [PDF](#) | [Rights and permissions](#) | [Save this link](#)